



---

## User Guide

Please read this manual carefully before operating System. Retain it for future reference

iPECS is an Ericsson-LG Brand



## REVISION HISTORY

Version	Date	Description of Change	S/W Version
Issue 3.7Aa	SEP 12, 2007	Initial Release	
Issue 4.0Aa	JUN 27, 2009	Add iPECS-50A/50B/Micro/1200 Add iPECS-MG 100/300	D.0Ac
Issue 4.0Ab	AUG 14, 2009	Add iPECS, VM, Dial Pad Feature	
Issue 4.1Aa	APR 02, 2010	Add 64 bit OS/Machine	D.1Aa
Issue 4.1Ab	AUG 24, 2010	Company Name Change	D.1Ab
Issue 4.1Ac	JUN 08, 2011	Add iPECS-CM	D.1Bj
Issue 4.2Aa	JUL 19, 2012	Update for TSP vD.2Af (General edits) - lineDevSpecific : 'Get All Park Number, Note' changed iPECS-CM supports. - LINE_DEVSPECIFIC message : 'Preselected Message Selection has changed.' added - LINE_DEVSPECIFIC message : 'Park Number (iPECS-MG/CM)' added - Device Specific Data Format : 'All Park Number Data Format (iPECS- CM)' added	D.2Af
Issue 4.2Ab	AUG 20, 2012	- LINE_DEVSPECIFIC message : 'System has restarted' added	All version
Issue 5.0	JAN 23, 2014	CI is changed to Ericsson-LG Enterprise.	All version
Issue 5.1	MAY 2, 2016	- Update Chapter 3, 4, & 5 iPECS SBG-1000, iPECS UCP & iPECS eMG80/eMG800 added - lineDevSpecific : 'Send SMS Message' added - LINE_DEVSPECIFIC message : 'SMS Message has received' added - Device Specific Data Format : 'Station SMS Message Data Format, PSTN SMS Message Data Format' added	D.2De

---

**CONTENTS**

---

**About This Guide.....1**

    Audience .....1

    Associated Documentation.....1

**1. Introduction.....2**

    1.1 What is the TAPI Application and Ericsson-LG Enterprise TSP .....2

    1.2 Enabling the TAPI Applications to use Ericsson-LG Enterprise system .....2

**2. Hardware/Software Requirements .....4**

    2.1 Computer Requirements .....4

    2.2 Key Telephone systems Requirement.....4

**3. Ericsson-LG Enterprise TSP Installation & Configuration .....6**

    3.1 Installation Procedure .....6

**4. 1<sup>st</sup> party connection .....12**

    4.1 ipLDK-20/60/Nexer/Aria SOHO .....12

    4.2 ipLDK-50/100/300/600.....15

    4.3 iPECS-LIK, MG, SBG-1000, iPECS UCP, iPECS eMG80/eMG800.....17

**5. 3<sup>rd</sup> party connection .....20**

    5.1 System Configurations .....20

    5.2 To configure Ericsson-LG Enterprise TSP.....23

**6. Telephony Server Configurations.....24**

    6.1 To enable or disable a telephony server .....24

    6.2 To assign a telephony user to a line or phone .....26

    6.3 To remove users from telephony lines or phones .....27

**7. Client Computer Configurations.....28**

    7.1 To specify telephony servers on a client computer .....28

    7.2 Client disable from telephony servers .....29

**8. Support For TAPI Functions .....30**

---

## **TSP User Guide**

---

8.1	Line Device Functions.....	30
8.2	Phone Device Functions .....	49
8.3	Device Specific Messages.....	56
9.	<b>Troubleshooting.....</b>	<b>69</b>

### About This Guide

This guide describes the use of Ericsson–LG Enterprise’s TSP, and the TSP (Telephony Service Provider) supporting Microsoft TAPI 2.1 for telephony applications. Those applications are referenced to as the TAPI application in the remainder of this guide.

### Audience

This guide is for anyone using Ericsson–LG Enterprise TSP to develop TAPI applications.

### Associated Documentation

#### ipLDK, iPECS Series Documentation

- Programming Guide for Digital Key Telephone System
- User's Guide for Digital Key Telephone

# 1. Introduction

## 1.1 What is the TAPI Application and Ericsson-LG Enterprise TSP

Ericsson-LG Enterprise TSP is the interface software or service provider that enables the application to access Ericsson-LG Enterprise Keyphone System.

Microsoft TAPI components included in Microsoft Windows use the routines in Ericsson-LG Enterprise TSP to access the system, and provide telephony functions to TAPI applications. Finally, the TAPI application can access Ericsson-LG Enterprise Keyphone System through the TAPI functions and Ericsson-LG Enterprise TSP routines.

The subsets of TAPI functions that Ericsson-LG Enterprise TSP supports include:

- Line Device Functions
- Phone Device Functions
- Device Specific Messages

For details of these functions, refer to Chapter 8 and associated documents described before.

**Note:** LDKSP is the filename of the Ericsson-LG Enterprise TSP.

**Note:** 1<sup>st</sup> party and 3<sup>rd</sup> party connection cannot be used at the same time.

## 1.2 Enabling the TAPI Applications to use Ericsson-LG Enterprise system

There are two modes enabling the TAPI applications to be serviced through Ericsson-LG Enterprise system. One is *the 3<sup>rd</sup> party mode* and the other is *the 1<sup>st</sup> party mode*.

*In the 3<sup>rd</sup> party mode*, referred to Figure 1.1, the TAPI application is on one of the client computers (may be Windows 2000/XP/Vista/7), which belongs to a Microsoft Windows domain serviced by the server computer (must be Windows 2000/2003/2008 Server). Ericsson-LG Enterprise TSP must be installed in the server computer, and the server computer must be connected to Ericsson-LG Enterprise system through the LAN. But in case of ipLDK-50/100/300/600, you can use RS-232C. The TAPI application can access Ericsson-LG Enterprise system through the Telephony RSP (Remote Service Provider) on the client computer through the network. Another TAPI application can access Ericsson-LG Enterprise system on another client computer.

*In the 3<sup>rd</sup> party mode*, the TAPI application on the client can access the line(s), which is(are) assigned to the client by the server computer.

*In the 1<sup>st</sup> party mode*, referred to Figure 1.1, the TAPI application is on the desktop computer (Windows 2000/XP/Vista/7), which is connected to the external CTI module or CTIU with the RS-232C port. The CTI Module/CTIU is connected to the keyset. The model names of keyset, which can be used in the 1<sup>st</sup> party mode, are LDP or LKD Scout chip (ipLDK-100/300/600).

*In ipLDK-20/60/Aria Soho/Nexer systems*, DKT and SLT can be used for 1<sup>st</sup> party mode using LAN connection.

*In the 1<sup>st</sup> party mode*, the TAPI application on the desktop computer can access only one line, which is connected to the keyset. And, a few features of the lineDevSpecific function

would not be supported.

**Note:** iPECS-CM system does not support 1<sup>st</sup> party connection.

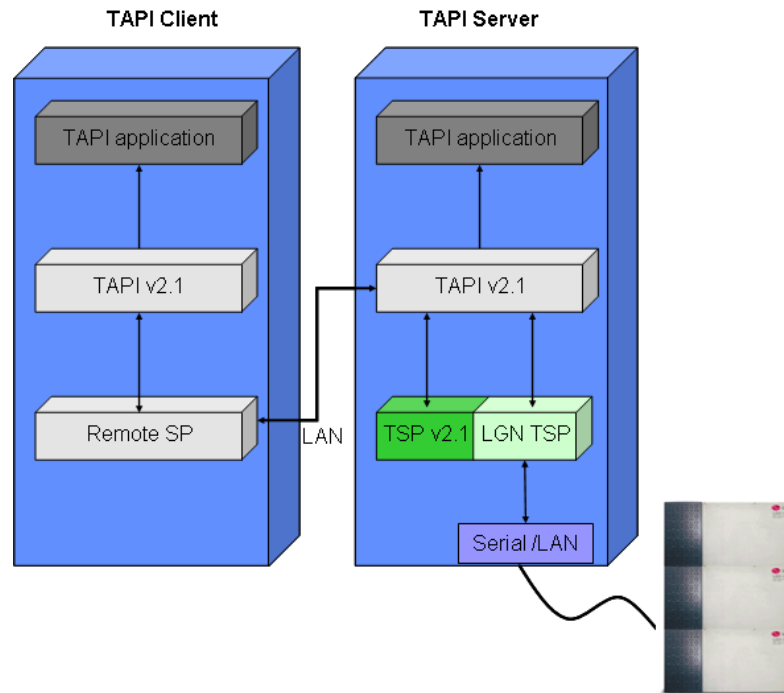

Figure 1.1 CTI Architecture of 3<sup>rd</sup> party mode

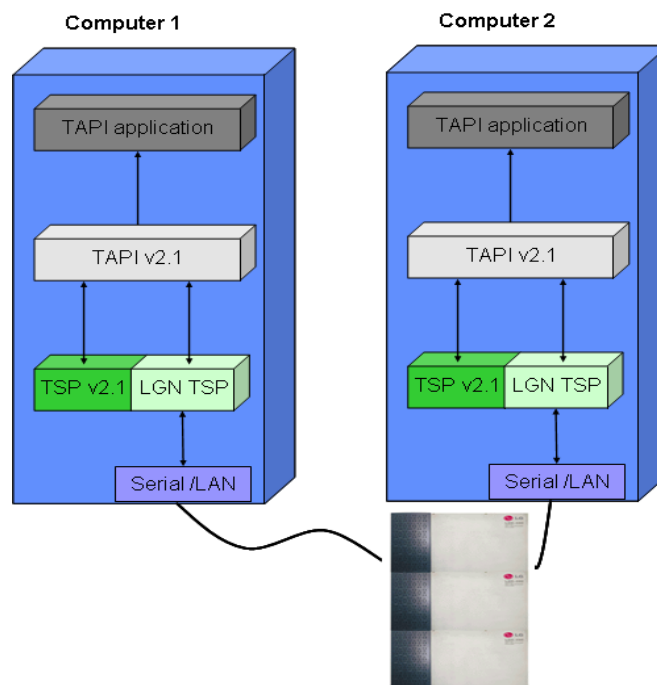

Figure 1.2 CTI Architecture of 1<sup>st</sup> party mode

## 2. Hardware/Software Requirements

### 2.1 Computer Requirements

The computer requirements are as follows:

- Server/Client (for 3<sup>rd</sup> party connection)
  - Telephony Server: Windows 2000/2003/2008 Server
    - CPU: Pentium III 500 MHz or later
    - RAM: 128 MB or later
    - Available Hard disk: 500 MB or later
  - Client: Windows 2000 or later
    - CPU: Pentium II 200 MHz or later
    - RAM: 32MB or later
    - Available Hard disk: 200 MB or later
- Desk top (for 1<sup>st</sup> party connection)
  - CPU: Pentium II 200 MHz or later
  - RAM: 32MB or later
  - Available Hard disk: 200 MB or later

### 2.2 Key Telephone systems Requirement

The System requirements are as follows:

- System: Key/PBX System (ipLDK, iPECS-LIK, iPECS-MG, iPECS-CM, iPECS SBG-1000, iPECS UCP, iPECS eMG80/eMG800)
- To use ipLDK-50/100/300/600 1<sup>st</sup> party connection
  - CTI Module (Model:V70, LKD keyset with Scout chip)
  - CTIU enabled LDP keyset
- To use ipLDK-20/60/Nexer/ARIA SOHO 1<sup>st</sup> party connection
  - Terminal Type  
DKT, SLT, WKT (GDC-345H or later, Middleware: 1.0I or later)
  - You need 1<sup>st</sup> party lock key or ez Phone lock key.
- To use 3<sup>rd</sup> party connection in ipLDK, iPECS-LIK, iPECS-MG, iPECS-CM, iPECS SBG-1000, iPECS UCP and iPECS eMG80/eMG800 systems
  - Terminal Type  
DKT, SLT, WKT, LIP (GDC-345H or later, Middleware: 1.0I or later)
  - You need 3<sup>rd</sup> party lock key



## TSP User Guide

---

- For ipLDK-50/100, ASMU is needed.
  
- To use 1<sup>st</sup> party connection in iPECS-LIK, iPECS-MG, iPECS SBG-1000, iPECS UCP, and iPECS eMG80/eMG800 systems
  - Terminal Type  
DKT, SLT, WKT, LIP (GDC-345H or later, Middleware: 1.0l or later)

**Note:** From the point of TSP' s view, iPECS SBG-1000, iPECS UCP and iPECS eMG80/eMG800 are considered as the same family series with iPECS-LIK. Thus, the way to configure TSP in iPECS SBG-1000, iPECS UCP and iPECS eMG80/eMG800 is the same with that of iPECS-LIK.

### 3. Ericsson-LG Enterprise TSP Installation & Configuration

#### 3.1 Installation Procedure

1. Run Setup.exe in Ericsson-LG Enterprise TSP install version.

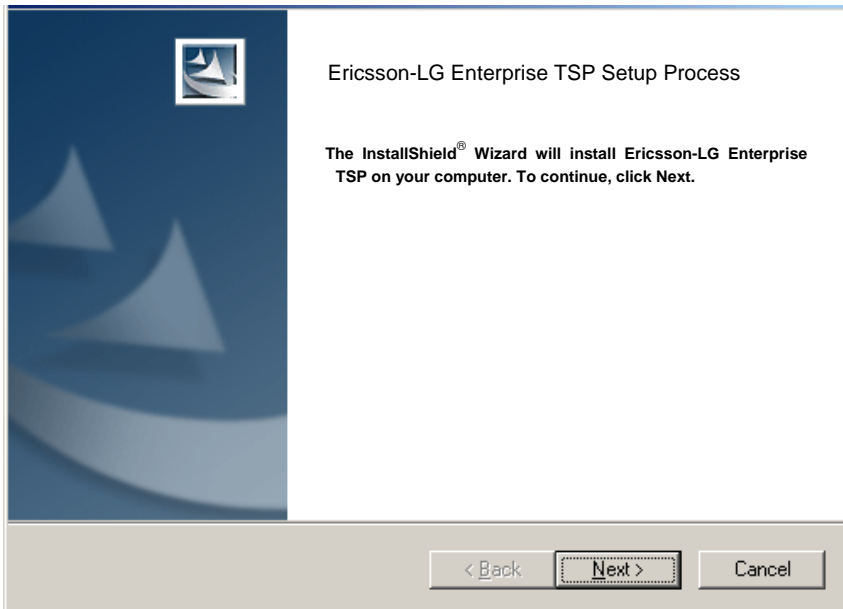

2. Click [Next] button.

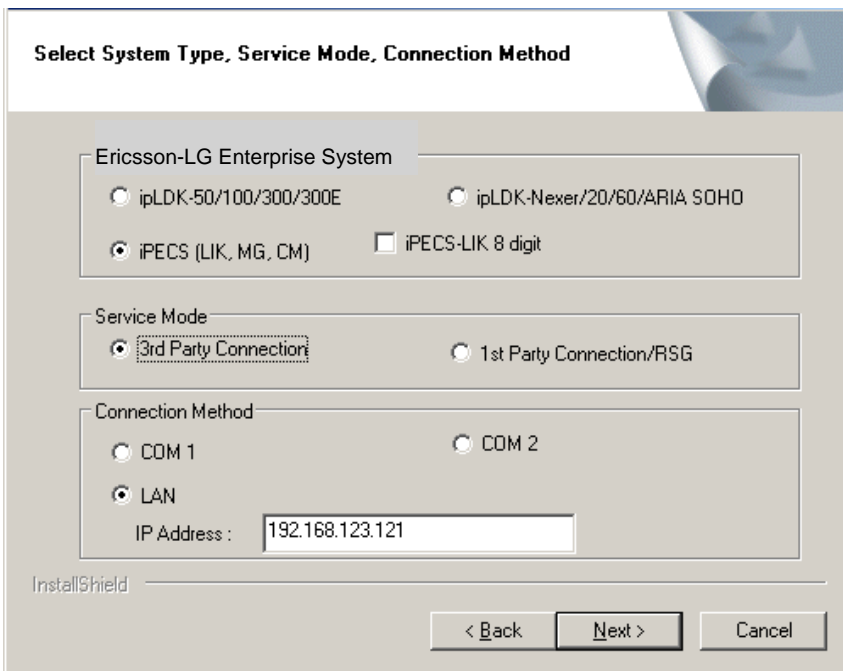

- Select your system that will be communicated with TSP. If your system is SBG-1000, UCP or eMG80/eMG800 then select LIK.

## TSP User Guide

---

- Select service mode as either 3rd Party Connection or 1st Party Connection/RSG
- Select Connection Method. LAN method requires the IP address of the system. If the system is behind the firewall, enter the firewall IP address.
- Click [Next] button.

**Note:** Only iPECS-LIK family (i.e. SBG-1000, UCP and eMG80/eMG800) and iPECS-MG can support the firewall environment. That is, although iPECS-LIK and iPECS-MG are located behind NAT, TSP and iPECS-LIK/iPECS-MG can communicate with each other.

3. If you select 1<sup>st</sup> party connection at the previous step, you need to insert Station Number and its password for 1<sup>st</sup> party connection of iPECS-LIK, iPECS SBG-1000, iPECS UCP, iPECS eMG80/eMG800, iPECS-MG, ipLDK-60 and Aria Soho IP systems.

**Enter Station Number and Password**

You can find a password in PGM Authorisation Code Table

Station Number :

Station Password :

InstallShield

< Back   Next >   Cancel

4. WinPcap Installation Window will open. If you don't have WinPcap on your PC, you should not skip this step. Without WinPcap, ELG TSP cannot receive the message from the system.

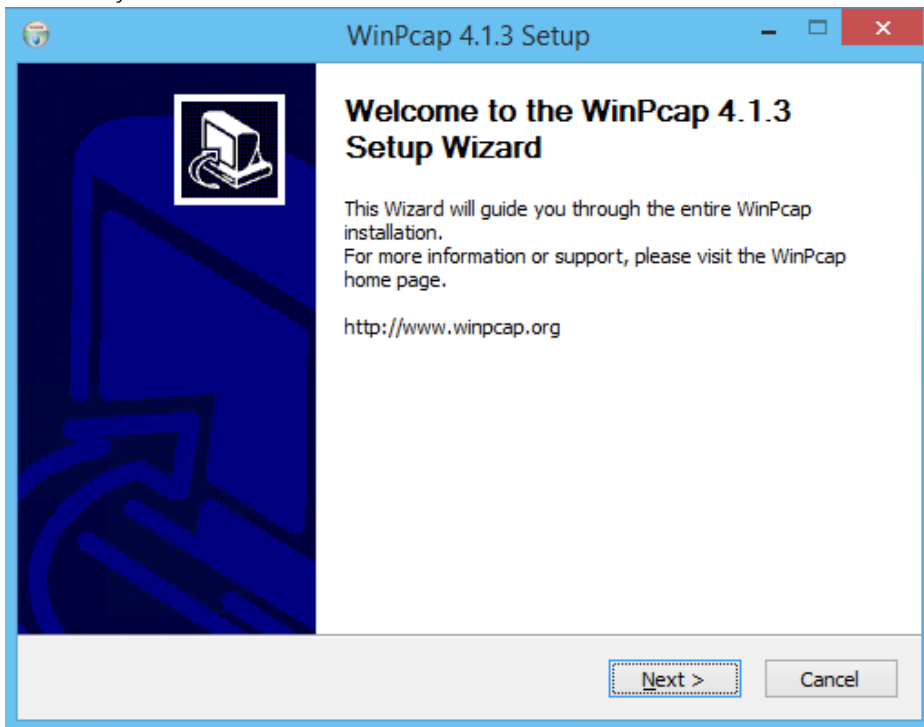

5. Restart your computer to connect between Ericsson-LG Enterprise TSP and Ericsson-LG Enterprise system.

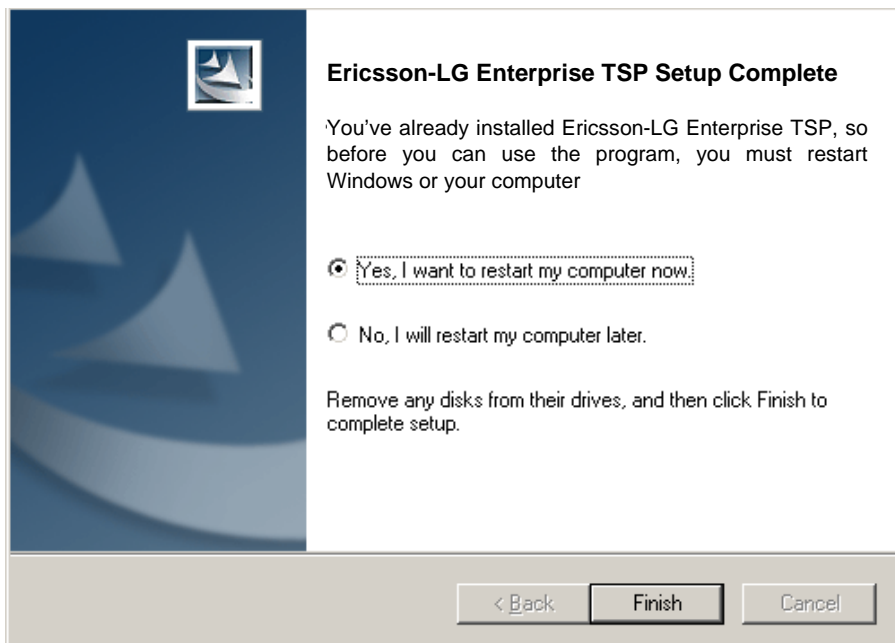

## TSP User Guide

---

6. You can change the Ericsson–LG Enterprise TSP configurations as following
7. Open **[Phone and Modem Options]** in Control Panel.

Location Information

Before you can make any phone or modem connections, Windows needs the following information about your current location.

What country/region are you in now?  
Korea

What area code (or city code) are you in now?  
031

If you need to specify a carrier code, what is it?  
[ ]

If you dial a number to access an outside line, what is it?  
9

The phone system at this location uses:  
 Tone dialing  Pulse dialing

OK Cancel

- Select country/region, insert area code and outside dial number.

Phone and Modem

Dialing Rules Modems Advanced

The list below displays the locations you have specified. Select the location from which you are dialing.

Locations:

Location	Area Code
My Location	031

New... Edit... Delete

OK Cancel Apply

8. On the [Advanced] tab under Providers, click [Telephony Service Provider for Ericsson-LG Enterprise System].

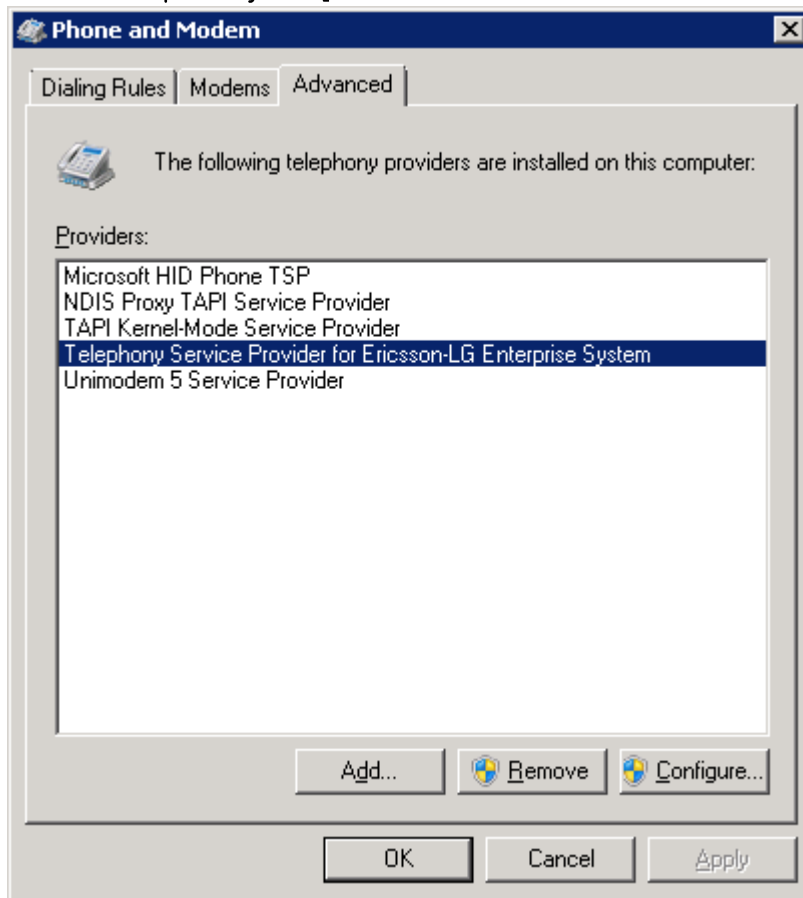

9. Click [Configure...].

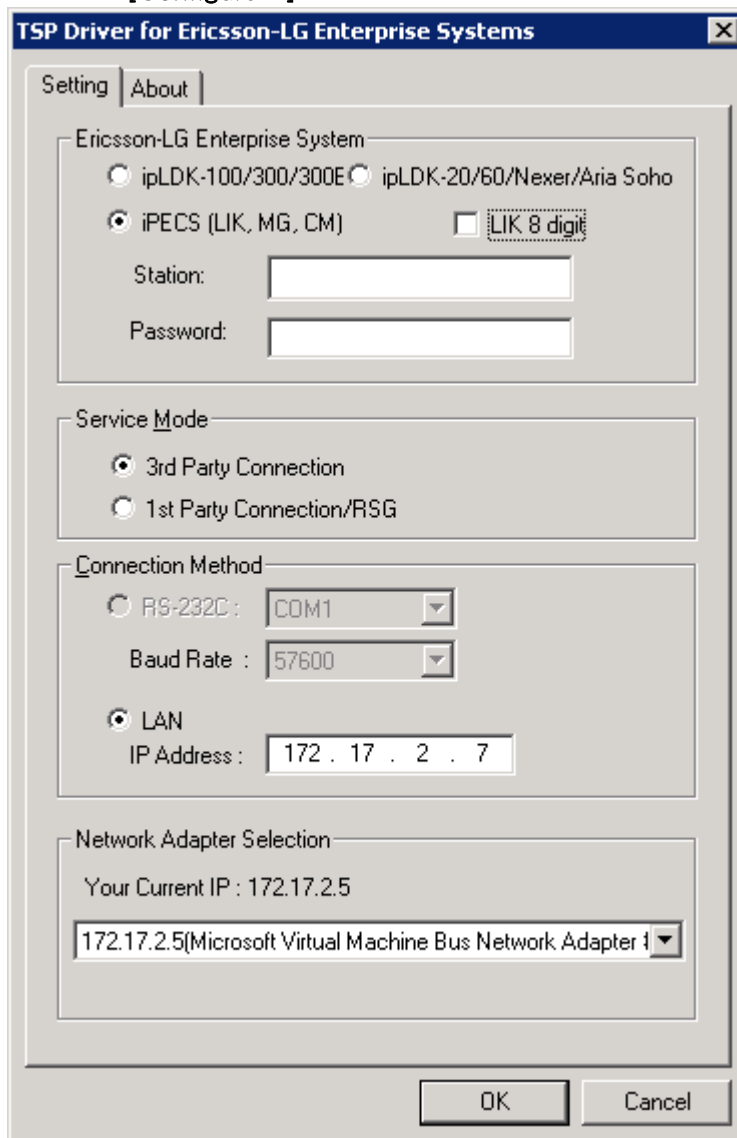

10. You can change Ericsson-LG Enterprise TSP configurations in this dialog.

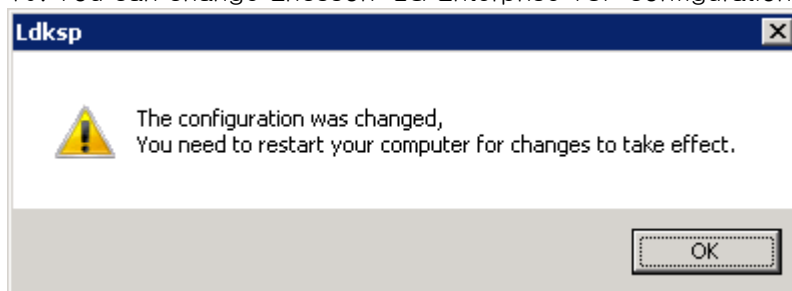

11. If the configurations were changed, you should restart your computer to take effect.

## 4. 1<sup>st</sup> party connection

A computer is communicating with ipLDK system directly. You should install Ericsson-LG Enterprise TSP on your local computer.

### 4.1 ipLDK-20/60/Nexer/Aria SOHO

#### 4.1.1. System configurations

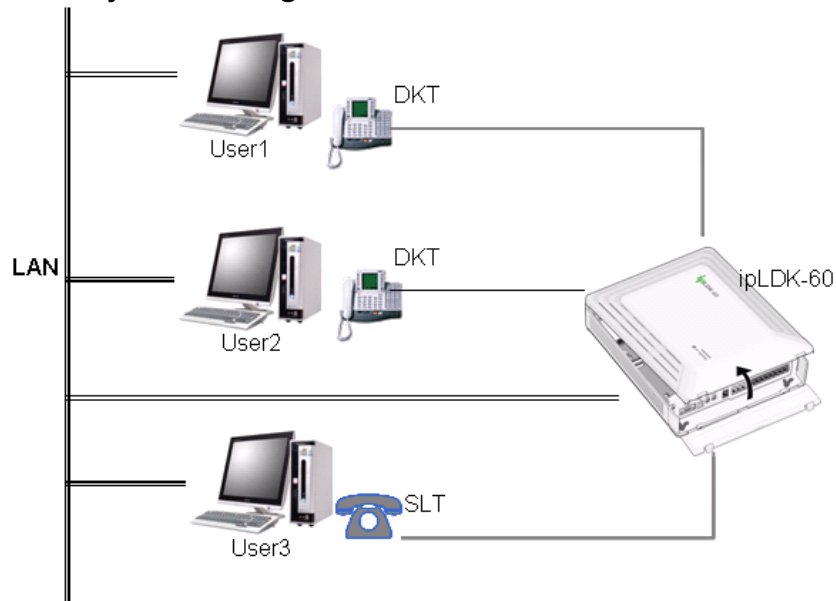



## 4.1.2. To assign a user to a line

- Ericsson-LG Enterprise TSP uses ID and Password of the TSP dialog box.
  - ipLDK-60 USA: US88P-C.8Ia or later.
  - ipLDK-60 STD: GS88P-C.1Ib or later.
  - Aria Soho IP: GS68P-C.8Fd or later.
- If the MPB version is lower than above, In PGM 126, a user should type a client IP address in Edit box, click **[Update]** button.

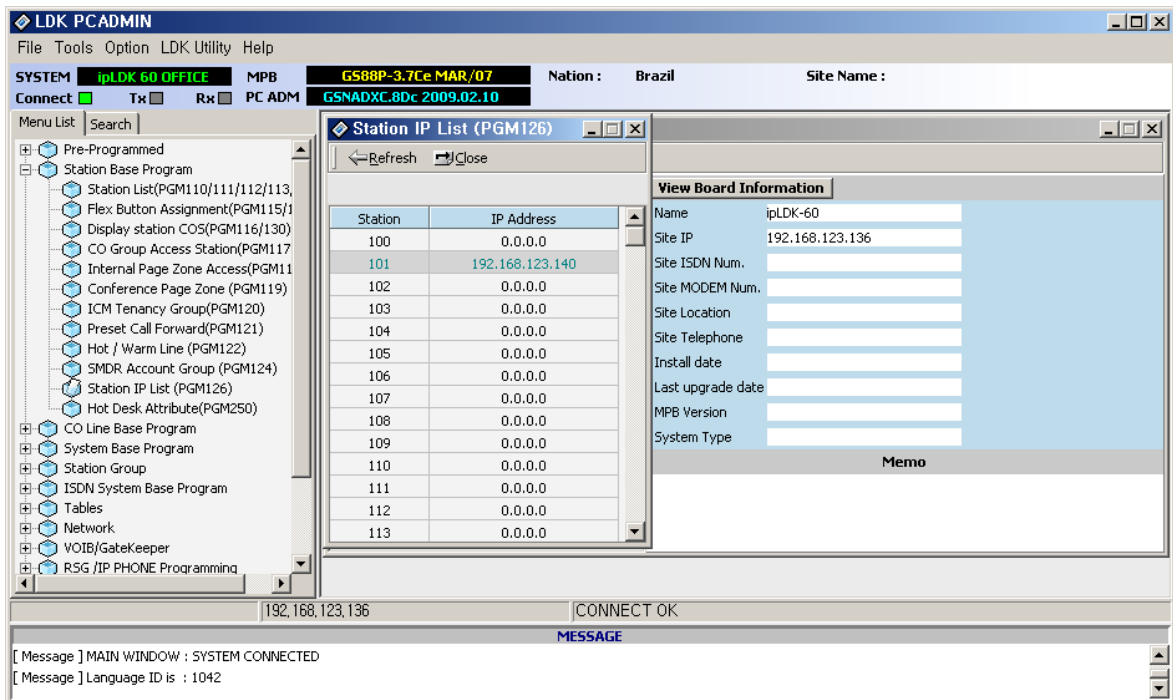

### 4.1.3. To configure Ericsson-LG Enterprise TSP

1. Verify Ericsson-LG Enterprise TSP configurations.

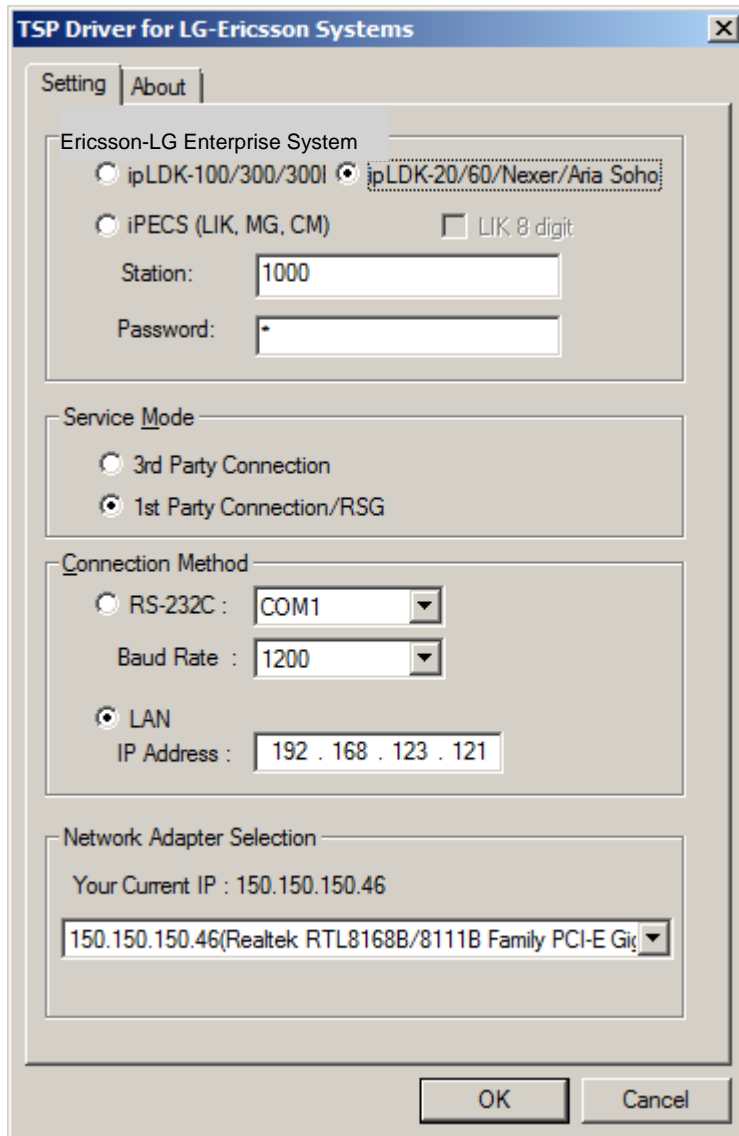

The screenshot shows the 'TSP Driver for LG-Ericsson Systems' configuration window. It has two tabs: 'Setting' and 'About'. The 'Setting' tab is active. The window is divided into several sections:

- Ericsson-LG Enterprise System:** Contains three radio buttons: 'ipLDK-100/300/300I', 'ipLDK-20/60/Nexer/Aria Soho' (which is selected), and 'iPECS (LIK, MG, CM)'. There is also a checkbox for 'LIK 8 digit' which is unchecked. Below these are text boxes for 'Station:' (containing '1000') and 'Password:' (containing a single asterisk).
- Service Mode:** Contains two radio buttons: '3rd Party Connection' and '1st Party Connection/RSG' (which is selected).
- Connection Method:** Contains two radio buttons: 'RS-232C' and 'LAN' (which is selected). Under 'RS-232C', there are dropdown menus for 'COM1' and 'Baud Rate : 1200'. Under 'LAN', there is a text box for 'IP Address : 192 . 168 . 123 . 121'.
- Network Adapter Selection:** Shows 'Your Current IP : 150.150.150.46' and a dropdown menu with the selected item '150.150.150.46(Realtek RTL8168B/8111B Family PCI-E Gigabit Ethernet Controller)'. At the bottom of the window are 'OK' and 'Cancel' buttons.

- Verify if ipLDK-20/60/Nexer/Aria Soho is selected.
- Verify if Station Number and Password are correct.
- Verify if 1<sup>st</sup> party Connection/RSG in Service Mode is selected.
- Verify if LAN is selected, and IP address of system is correct.

### 4.2 ipLDK-50/100/300/600

#### 4.2.1. System configurations

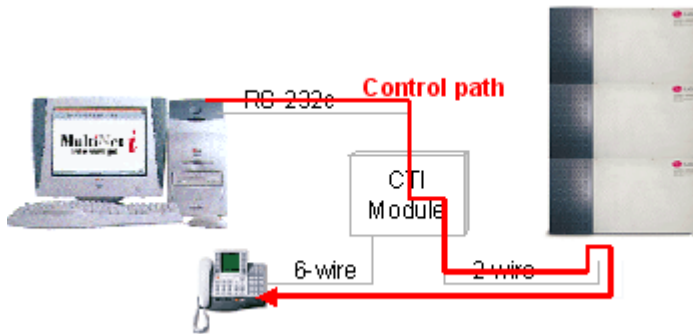

[Figure, How to use CTI Module]

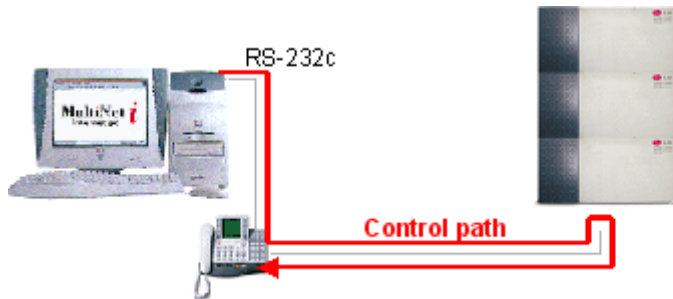

[Figure, How to use CTIU enabled keyset]

- In case of using CTI module, CTI module (Model: V70) is connected to LKD with Scout chip.
- CTIU enabled LDP keyset is available.

### 4.2.2. To configure Ericsson-LG Enterprise TSP

#### 1. Verify Ericsson-LG Enterprise TSP configurations

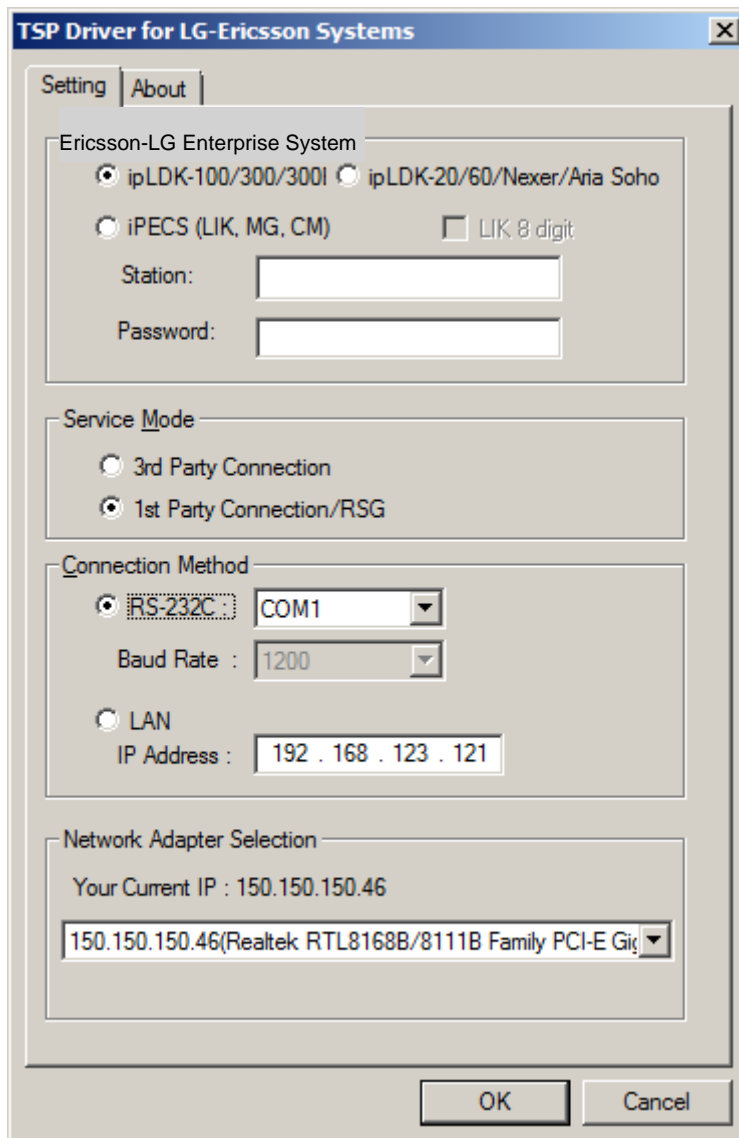

- Verify if ipLDK-50/100/300/300E is selected in Ericsson-LG Enterprise System.
- Station number and its password are not used.
- Verify if 1<sup>st</sup> party Connection/RSG is selected in Service Mode
- Verify if serial number is correct, In case of RSG, LAN connection is available.

### 4.3 iPECS-LIK, MG, SBG-1000, iPECS UCP, iPECS eMG80/eMG800

#### 4.3.1. System configurations

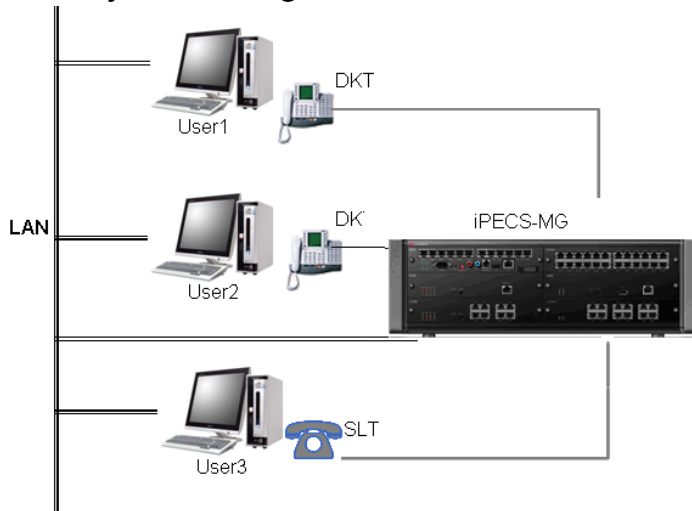

#### 4.3.2. To assign a user to a line

1. You don't have to add any program. (iPECS-LIK 5.5cc or later & SBG-1000, iPECS UCP, iPECS eMG80/eMG800)

Just memorize the corresponding authorization code for station's password.

The screenshot shows the iPECS Administration web interface. The main content area is titled '[ Authorization Code Table ]'. At the top, there are filter options for 'Day' (N/A), 'Night' (N/A), and 'Timed Ring' (N/A), along with a 'Filter' button and a 'Save' button. Below the filters is a table with columns for 'Index', 'Authorization Code', and 'COS'. The table contains 15 rows, indexed from 1000 to 1014. Each row has a 'MAX 12 Digits (Include \*)' field for the authorization code and three dropdown menus for 'DAY', 'Night', and 'Timed Ring', all currently set to '1'. Above the table, there are two lines of authorization codes: '[Station]: [100-149][150-199][200-249][250-299][300-349][350-399]' and '[System]: [001-050][051-100][101-150][151-200][201-250][251-300][301-350][351-400][401-450][451-500][501-550][551-600][601-650][651-700]'. A left sidebar contains a menu with various system configuration options, with 'Authorization Code Table(227) [N]' highlighted.

# TSP User Guide

2. If you use an iPECS–MG system, memorize the Station Password.

The screenshot shows the configuration interface for a Station Directory Number Attribute. The left sidebar contains a menu with the following items: Pre-Programmed Data, Numbering Plan, Station Port Data, Station Number Data (highlighted), Station DN Assignment(130)[N], Station DN Attribute(131~135)[N] (highlighted), Private CO Attribute(136)[N], COS Assignment(137)[N], Auto Dial Attribute(138)[N], Preset Call Forward(142)[N], Call Forward(143)[N], and VMIB Attribute(145,147)[N]. The main window title is "[ Station Directory Number Attribute ]". It features an "Enter Station Range" field with "Load" and "Overview" buttons, and a "Save" button. Below this, it indicates "Station Range From 100 to 100". A table lists attributes for "PGM 131":

Order	Uncheck All	Attribute	Value
PGM 131			
1	<input checked="" type="checkbox"/>	Station Name	<input type="text"/>
2	<input checked="" type="checkbox"/>	Tenant Group (1-5)	1
3	<input checked="" type="checkbox"/>	Digit Conversion Table (1-9)	1
4	<input checked="" type="checkbox"/>	Password	.....
5	<input checked="" type="checkbox"/>	Busy Service	Busy Tone
6	<input checked="" type="checkbox"/>	Charge Mode	REPORT
7	<input checked="" type="checkbox"/>	SMDR Dialed Digit Hidden	DISABLE
8	<input checked="" type="checkbox"/>	Hotdesk Agent Number	OFF
9	<input checked="" type="checkbox"/>	Time Table Index (1-8, empty, not assign)	<input type="text"/>

### 4.3.3. To configure a Ericsson-LG Enterprise TSP

1. Verify Ericsson-LG Enterprise TSP configurations.

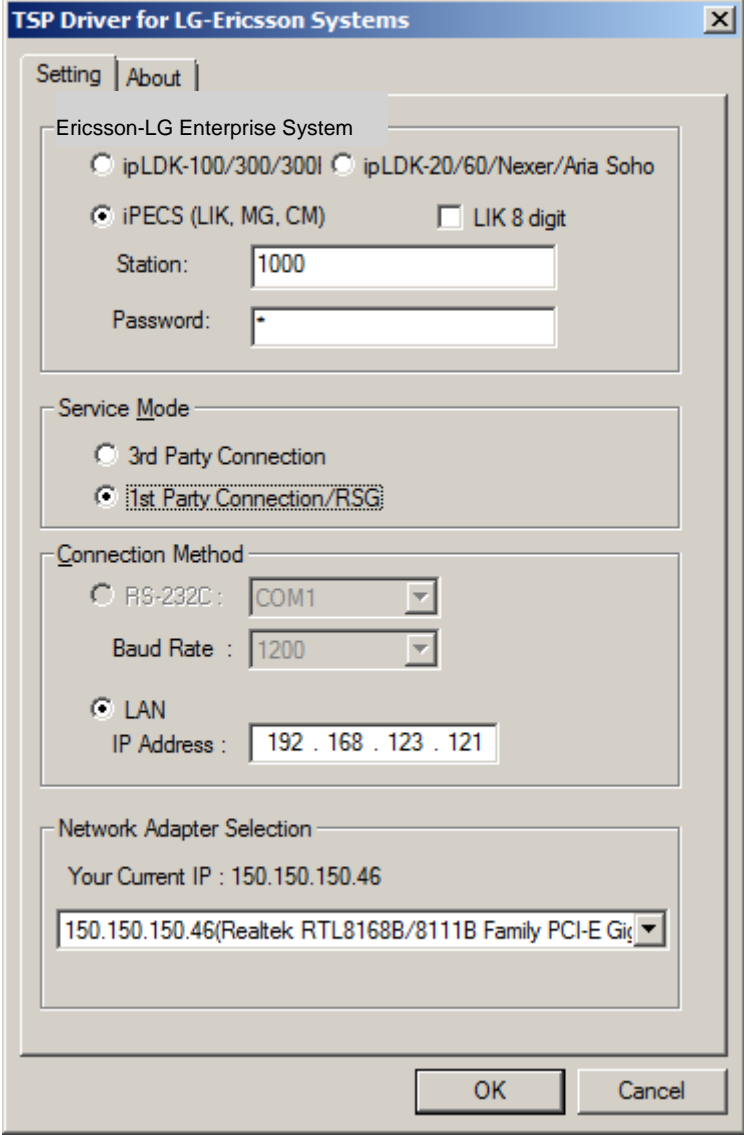

The screenshot shows the 'TSP Driver for LG-Ericsson Systems' configuration window. It has two tabs: 'Setting' and 'About'. The 'Setting' tab is active and contains several sections:

- Ericsson-LG Enterprise System:** Contains radio buttons for 'ipLDK-100/300/300I' and 'ipLDK-20/60/Nexer/Aria Soho'. The 'iPECS (LIK, MG, CM)' option is selected. There is an unchecked checkbox for 'LIK 8 digit'. Below are text boxes for 'Station:' (containing '1000') and 'Password:' (containing a single dot).
- Service Mode:** Contains radio buttons for '3rd Party Connection' and '1st Party Connection/RSG'. The '1st Party Connection/RSG' option is selected.
- Connection Method:** Contains radio buttons for 'RS-232C' and 'LAN'. The 'LAN' option is selected. Below are dropdown menus for 'COM1' and '1200', and a text box for 'IP Address:' containing '192 . 168 . 123 . 121'.
- Network Adapter Selection:** Shows 'Your Current IP : 150.150.150.46' and a dropdown menu with the selected item '150.150.150.46(Realtek RTL8168B/8111B Family PCI-E Gi...'.

At the bottom of the window are 'OK' and 'Cancel' buttons.

- Verify if iPECS (LIK, MG, CM) is selected.
- Verify if station number and its password are correct.
- Verify if 1<sup>st</sup> party Connection/RSG is selected in Service Mode.
- Verify if LAN is selected, and IP address of system is correct in Connection Method.
- Check LIK 8 digit if Prefix Usage in PGM 238 (i.e. 8 Digit Table) turns ON in LIK, SBG-1000, UCP and eMG80/eMG800 systems

## 5. 3<sup>rd</sup> party connection

For 3<sup>rd</sup> party connection, you need a Server computer (Windows 2000/2003/2008 Server). You should install Ericsson-LG Enterprise TSP on Server computer. In client PC, TAPI Application is communicating with its server through RSP (Remote Service Provider).

### 5.1 System Configurations

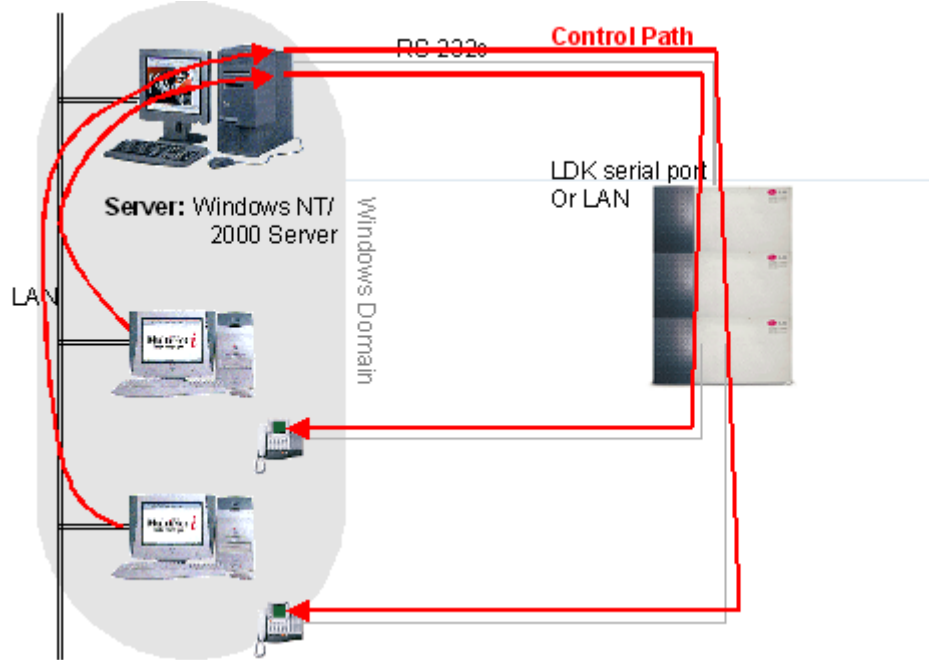

1. iPECS-LIK, iPECS SBG-1000, iPECS UCP, iPECS eMG80/eMG800

Board Based Data	53	3-Way Conference Preference	MCIM	
CO Line Data	54	First Digit * in Speed	DISPLAY SECURITY	
System Data	55	Use Strong Password	OFF	
System Attributes(160~161) [N]	56	VSF/MIM SMTP Port	25	00001-65535
System Password(162) [N]	57	CTI IP	150.150.131.147	
Alarm Attributes(163) [N]	58	Intercom Busy Service	Voice Over	
Attendant Assignment(164) [N]	59	Auto save new message	OFF	
Multicast RTP/RTCP(165) [N]	60	IGMP Query Usage	OFF	
DISA COS(166) [N]	61	IGMP Query Interval Timer	180 (*1sec)	0000 - 3600

- Enter TAPI Server's IP address at 'CTI IP' in the System Attributes.



## 2. iPECS-MG

<ul style="list-style-type: none"> <li>Station Group Data</li> <li><b>System Data</b> <ul style="list-style-type: none"> <li>System Timer(220~222)[N]</li> <li><b>System Attribute(223)[N]</b></li> <li>System Security(224)[N]</li> <li>System Authorization Code(225)[N]</li> <li>System Password(226)[N]</li> <li>Alarm Attribute(227)[N]</li> <li>External Control Contact(228)[N]</li> <li>Music Source(229)[N]</li> </ul> </li> </ul>			
8	Web Server Port	80	00001-65535
9	Database Auto USB download	OFF	
10	Database Auto Download Hour	0	00-23
11	UCS Server IP Address	0.0.0.0	IP address
12	CTI Server IP Address	150.150.131.147	IP address
13	MODEM Associated CO Line	0	
14	IP Phone Registration by STA Number	OFF	
15	Analog Line BUSY Tone Detection Times	4	
16	Analog Line ERROR Tone Detection Times	5	

- Enter TAPI Server' s IP address at ' CTI Server IP Address' in the System Attributes.

## 3. iPECS-CM

The screenshot shows the iPECS-CM System Configuration interface. The 'TAPI Server Information' window is open, displaying a table with the following data:

Server IP Address	Server Port	Connect State
124.46.120.58	5588	<span style="color: green;">■</span>

Below the table, a message reads 'Process Success!'.

- Enter TAPI Server' s IP address at ' Server IP Address' of TAPI Server Information.

The screenshot shows the iPECS-CM System Configuration interface. The 'TAPI Agent Group' window is open, displaying a table with the following data:

Index	Tenant	Phone No.
<input checked="" type="checkbox"/>	1	41066
<input type="checkbox"/>	2	43000
<input type="checkbox"/>	3	43001
<input type="checkbox"/>	4	43002
<input type="checkbox"/>	5	43003
<input type="checkbox"/>	6	42016
<input type="checkbox"/>	7	43005
<input type="checkbox"/>	8	43006
<input type="checkbox"/>	9	43007
<input type="checkbox"/>	10	43008
<input type="checkbox"/>	11	43009

The window also shows a 'Member Count 114' and search fields for 'Tenant' and 'Phone No.'.

- Stations that will be managed by TAPI Server should be entered at TAPI Agent Group.

### 4. ipLDK, SBG-1000

- No system configuration needed. (refer to the system' s administration manual).

### 5.2 To configure Ericsson-LG Enterprise TSP

#### 1. Verify Ericsson-LG Enterprise TSP configurations

The screenshot shows the 'TSP Driver for LG-Ericsson Systems' configuration window. It has a title bar with a close button. Below the title bar are two tabs: 'Setting' (selected) and 'About'. The window is divided into several sections:

- Ericsson-LG Enterprise System:** Contains radio buttons for 'ipLDK-100/300/300I' and 'ipLDK-20/60/Nexer/Aria Soho'. The 'iPECS (LIK, MG, CM)' option is selected. There is a checkbox for 'LIK 8 digit' which is unchecked. Below these are text input fields for 'Station:' and 'Password:'.
- Service Mode:** Contains radio buttons for '3rd Party Connection' (selected) and '1st Party Connection/RSG'.
- Connection Method:** Contains radio buttons for 'RS-232C' and 'LAN'. The 'LAN' option is selected. Under 'RS-232C', there are dropdown menus for 'COM1' and 'Baud Rate : 57600'. Under 'LAN', there is a text input field for 'IP Address : 192 . 168 . 123 . 121'.
- Network Adapter Selection:** Contains the text 'Your Current IP : 150.150.150.46' and a dropdown menu showing '150.150.150.46(Realtek RTL8168B/8111B Family PCI-E Gi...'.

At the bottom of the window are 'OK' and 'Cancel' buttons.

- Verify if the kind of system is correct.
- Verify if 3<sup>rd</sup> party connection is selected.
- In case of ipLDK-50/100/300/300E and ipLDK-60, you can use anyone of connection Method. But in case of the others, only LAN connection is available.
- Check LIK 8 digit if Prefix Usage in PGM 238 (i.e. 8 Digit Table) turns ON in LIK, SBG-1000, UCP and eMG80/eMG800 systems.

## 6. Telephony Server Configurations

### 6.1 To enable or disable a telephony server Windows 2000/2003/2008 Server

- 1) Open **Telephony**

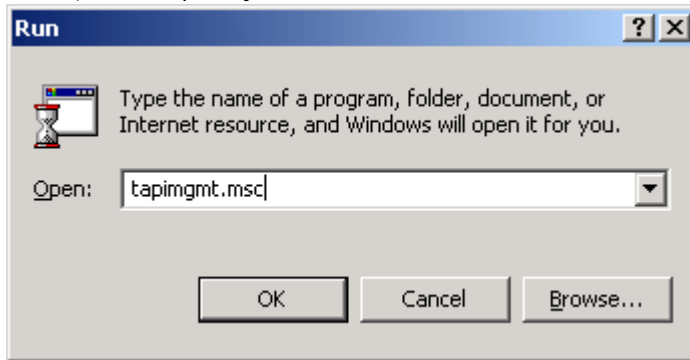

- To open **Telephony** on Windows 2000/2003/2008 Server, click **Start**, click **Run**, and then type **tapimgmt.msc**.

- 2) In the console tree, click the server you want to manage.
- 3) In the **Action** menu, click **Properties**.

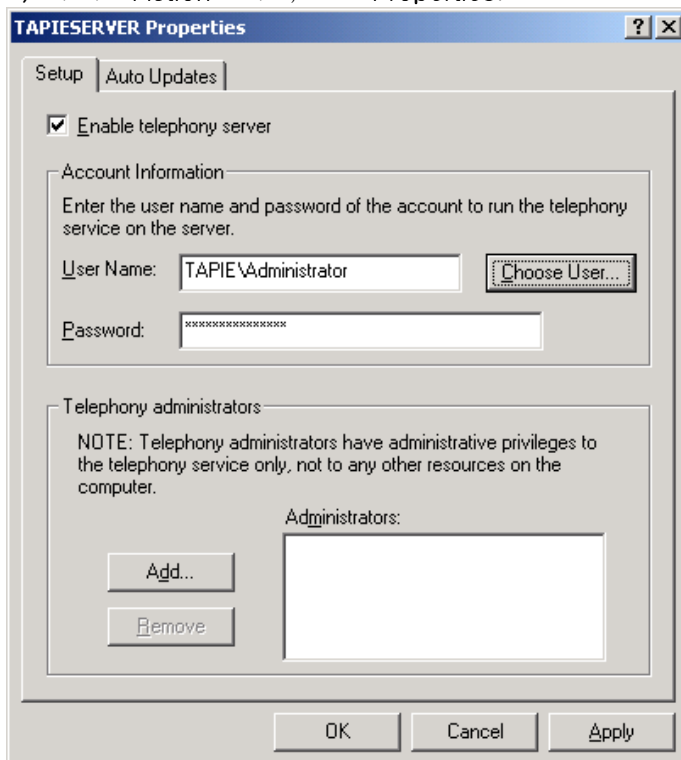

- 4) On the **Setup** tab, select the **Enable telephony server** check box to enable the server or clear the check box to disable the server.

- 5) When you enable the server, specify a logon account under **Account Information**. It must be a member of the Administrators group on the server, and also be in the same domain as the server or in a domain that has a two-way trust relationship with the domain containing the server.

This procedure changes whether clients can use the telephony devices on the server. Changes take effect the next time the system attempts to start the TAPI service.

If the **Enable telephony server** check box is unavailable, you need to start the Telephony service first. To manage the Telephony service, you must be a telephony administrator on the server or logged on as an administrator of the server.

### 6.2 To assign a telephony user to a line or phone Windows 2000/2003/2008 Server

- 1) Open **Telephony**
- 2) In the console tree, click **Telephony Service Provider for Ericsson-LG Enterprise System**.

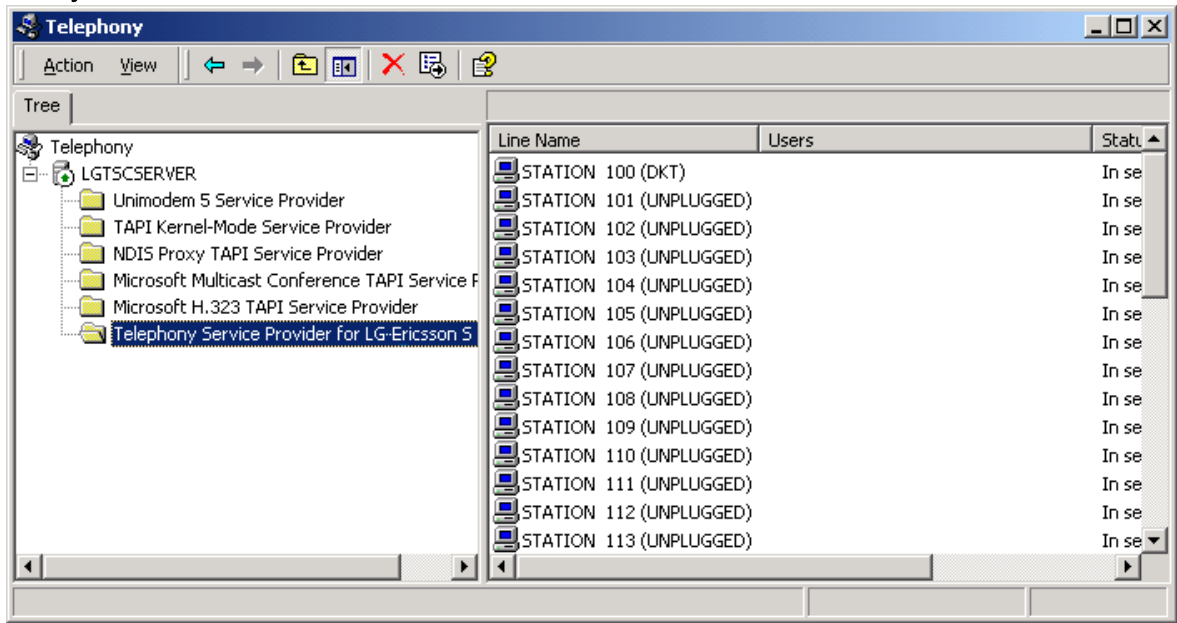

- 3) In the details pane, under **Line Name** or **Phone Name**, click the line or phone.
- 4) In the **Action** menu, click **Edit Users**, and then click **Add**.
- 5) In **Look in**, click the domain containing the user.
- 6) In the list, select the user, and then click **Add**.

This procedure permits TAPI client programs run by the user to use the line or phone on the server. A user added for a phone or line must be in the same domain as the TAPI server or in a domain that has a two-way trust relationship with the domain containing the server. Before a user can use the telephony line or phone, the TAPI server must be specified on the client computer.

### 6.3 To remove users from telephony lines or phones

#### Windows 2000/2003/2008 Server

- 1) Open Telephony.
- 2) In the console tree, click **Telephony Service Provider for Ericsson-LG Enterprise System**.
- 3) In the details pane, under **Line Name** or **Phone Name**, click the line or phone.
- 4) In the **Action** menu, click **Edit Users**.
- 5) In **Assigned Users**, click a user, and then click **Remove**.

After you perform this procedure, TAPI client programs run by the user will be unable to use the line or phone on the TAPI server.

## 7. Client Computer Configurations

### 7.1 To specify telephony servers on a client computer

#### Windows 2000/XP/Vista/7

- 1) Open a **Command Prompt** window.
- 2) Type **Tcmsetup /c server1 server2...**

To open a Command Prompt window, click **Start**, point to **Programs**, point to **Accessories**, and then click **Command Prompt**.

The TAPI client is installed with the Microsoft Windows 2000 operating system, but you need to perform this procedure to specify servers for the client. The client must be in the same domain as the server or in a fully trusted domain.

You must log on to the client as an administrator to perform this command. If you are logged on to a computer in the Users or Power Users group, you can use the **runas** command to run **tcmsetup** as an administrator, for example:

- `runas /user:mydomainWmyname " tcmsetup /c servername"`

You may have to restart the Telephony service for this change to take effect.

When you use Windows Server 2003, the following service pack should be installed on a client computer.

- Windows 2000 Professional: Service Pack 5 or later.
- Windows XP Home: Service Pack 2 or later.
- Windows XP Professional: Service Pack 2 or later.

After you complete this procedure, you need to specify a TAPI server on the client. To make the telephony resources on the server available to the client users, the server administrator needs to assign the users to telephones or lines on the server. Users must log onto a valid domain account.

A Windows 95 TAPI client must be upgraded to TAPI2.1 to use the TAPI services provided by a Windows 2000 TAPI server.



### 7.2 Client disable from telephony servers

1) Open a Command Prompt window.

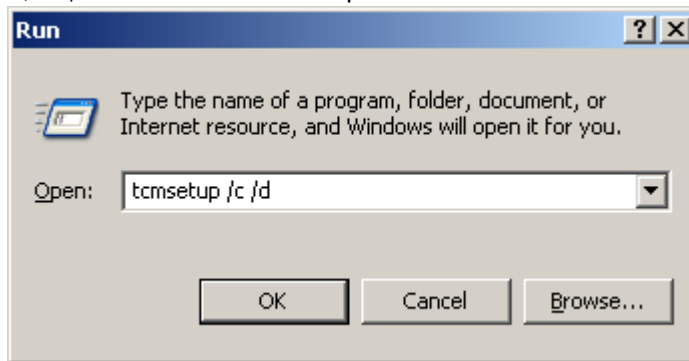

- tcmsetup /c /d

Client user cannot see the lines or phones.

## 8. Support For TAPI Functions

### 8.1 Line Device Functions

The following Sections describe TAPI Line Device functions supported by Ericsson-LG Enterprise TSP.

For more information about TAPI functions, refer to the *Microsoft Windows Telephony Application Programmer's Guide*.

TAPI Function	Ericsson-LG Enterprise TSP Support
lineAddProvider	Supported (TAPI itself).
lineAddToConference	Supported.
lineAnswer	Supported.
lineBlindTransfer	Supported.
lineClose	Supported.
lineCompleteCall	Supported.
lineCompleteTransfer	Supported.
lineConfigProvider	Supported (TAPI itself).
lineDeallocateCall	Supported (TAPI itself).
lineDevSpecific	Supported.
lineDial	Supported.
lineDrop	Supported.
lineForward	Supported.
lineGenerateDigits	Supported.
lineGetAddressCaps	Supported.
lineGetAddressID	Supported.
lineGetAddressStatus	Supported.
lineGetCallInfo	Supported.
lineGetCallStatus	Supported.
lineGetConfRelatedCalls	Supported.
lineGetCountry	Supported (TAPI itself).
lineGetDevCaps	Supported.
lineGetID	Supported.
lineGetLineDevStatus	Supported.
lineGetMessage	Supported (TAPI itself).
lineGetNewCalls	Supported.
lineGetProviderList	Supported (TAPI itself).
lineGetStatusMessages	Supported.
lineHold	Supported.
lineInitializeEx	Supported.
lineMakeCall	Supported.
lineNegotiateAPIVersion	Supported.
lineNegotiateExtVersion	Supported.

## TSP User Guide

---

TAPI Function	Ericsson-LG Enterprise TSP Support
lineOpen	Supported.
linePark	Supported.
linePickup	Supported.
linePrepareAddToConference	Supported.
lineRedirect	Supported.
lineReleaseUserUserInfo	Supported.
lineRemoveFromConference	Supported.
lineRemoveProvider	Supported (TAPI itself).
lineSendUserUserInfo	Supported.
lineSetCallData	Supported.
lineSetCallPrivilege	Supported.
lineSetStatusMessages	Supported.
lineSetupConference	Supported.
lineSetupTransfer	Supported.
lineShutdown	Supported.
lineSwapHold	Supported.
lineTranslateAddress	Supported (TAPI itself).
lineTranslateDialog	Supported (TAPI itself).
lineUncompleteCall	Supported.
lineUnhold	Supported.
lineUnpark	Supported.

The followings are more detail descriptions of Ericsson-LG Enterprise supporting TAPI functions. It was referred to MSDN Library.

### lineAnswer

The **lineAnswer** function answers the specified offering call. The function is completed asynchronously.

```
LONG lineAnswer(  
    HCALL hCall,  
    LPCSTR lpsUserUserInfo,  
    DWORD dwSize  
);
```

- Ericsson-LG Enterprise TSP supports the user-user information in the lpsUserUserInfo.
- SLT cannot use this function.

### lineCompleteCall

The **lineCompleteCall** function specifies how a call that could not be connected normally should be completed instead. The network or switch may not be able to complete a call because network resources are busy or the remote station is busy or doesn't answer. The application can request that the call be completed in one of a number of ways. The function is completed asynchronously.

```
LONG lineCompleteCall(  
    HCALL hCall,  
    LPDWORD lpdwCompletionID,  
    DWORD dwCompletionMode,  
    DWORD dwMessageID  
);
```

- **LINECALLCOMPLMODE\_CALLBACK:** A user can use this completion mode when the called user does not answer or the station status of the called user is DND(Do Not Disturb)
- **LINECALLCOMPLMODE\_CAMPON:** A user can use this completion mode when the station status of the called user is busy.
- **LINECALLCOMPLMODE\_INTRUDE:** When the called user does not answer the call, the Attendant user can use this completion mode.
- **LINECALLCOMPLMODE\_MESSAGE:** When the called user does not answer the call, the caller user leaves a voice message.

### lineDevSpecific

The **lineDevSpecific** function enables service providers to provide access to features not offered by other TAPI functions. The meanings of the extensions are device specific, and taking advantage of these extensions requires the application to be fully aware of them. The function is completed asynchronously.

```
LONG lineDevSpecific(  
    HLINE hLine,  
    DWORD dwAddressID,  
    HCALL hCall,  
    LPVOID lpParams,  
    DWORD dwSize  
);
```

- dwAddressID must be zero.

Ericsson-LG Enterprise TSP supports the following device-specific functions. Some features are supported only in the 3<sup>rd</sup> party mode:

- **Paging**

“ PAGE/xx...x” in the lpParams field where xx...x is:

1. INT\_PAGE\_Z + 2bytes: Announce your voice to the internal zone.
  - ipLDK, iPECS-LIK : INT\_PAGE\_Z01 ~ INT\_PAGE\_Z35
  - iPECS-MG : INT\_PAGE\_Z01 ~ INT\_PAGE\_Z30
  - iPECS-CM : INT\_PAGE\_Z00 ~ INT\_PAGE\_Z99
2. INT\_ALL\_CALL: Announce your voice to all internal zones.
  - ipLDK, iPECS (LIK, MG)
3. EXT\_PAGE\_Z01 + 2bytes: Announce your voice to the external zone .
  - ipLDK, iPECS-LIK : EXT\_PAGE\_Z01 ~ EXT\_PAGE\_Z03
  - iPECS-MG : EXT\_PAGE\_Z0

4. EXT\_ALL\_CALL: Announce your voice to all external zones.
  - ipLDK, iPECS (LIK, MG)
5. ALL\_CALL: Announce your voice to all external and internal zones.
  - ipLDK, iPECS (LIK, MG)
6. MEET\_ME: Answer and connect the announcing call.
  - ipLDK, iPECS (LIK, MG)

This function can be used when the call (hCall) is in the following status.

- in an idle status
- in an dial status
- in the status of hearing a dial tone, an error tone, or a busy tone

If a wrong lpParams is transferred, or the line device does not have a page access right, or anyone is using a page function, or there is no member in the transferred page zone, the IResult actual parameter of the corresponding ASYNC\_COMPLETION is LINEERR\_OPERATIONFAILED. The function is completed successfully

Ex) If you want to announce your voice to all internal zones, include the following codes to your application source code. Most device-specific functions use the similar method to the following source code.

```
char lpParam[]=" PAGE/INT_ALL_CALL" ;  
lineDevSpecific( hLine, dwAddressID, hCall, (LPVOID)lpParam, sizeof(lpParam) );
```

- **DVU (Digitized Voice Unit) (ipLDK)**

“ DVU/xx···x” in the lpParams field where xx···x is:

1. DATE; voice announcement of the date and the time.
2. STANO; voice announcement of the number of the station
3. OUTMSG\_REC; record customer message
4. OUTMSG\_DEL; delete customer message
5. OUTMSG\_PLAY; play customer message
6. STA\_STATUS; voice announcement of the following information of the station
  - Station Number
  - ICM Signaling Mode
  - Number of Message Waiting
  - Wake-up Time
  - DND state
  - Forwarded to other station
  - Forwarded to Speed Bin
  - Station COS X
7. PAGEMSG\_REC; record page announcement
8. PAGEMSG\_DEL; delete page announcement
9. PAGEMSG\_PLAY; play page announcement
10. MSGWAIT\_PLAY; play the message queued
11. MSGWAIT\_DEL; delete the current message
12. MSGWAIT\_PLAY\_NEXT; play next message queued

13. MSGWIAT\_REW: rewind the message due to admin setting.
14. MSGWAIT\_ADD: add voice message.
15. MSGWAIT\_CALLBACK: With CLI, make call to an external.
16. FORWARD\_UNCOND: set incoming call to forward to DVU unconditionally.
17. FORWARD\_BUSY: set incoming call to forward to DVU when It is busy.
18. FORWARD\_NOANSW: set incoming call to forward to DVU when it is no answer
19. FORWARD\_BUSYNA: set incoming call to forward to DVU when it is busy and no answer.

This function with lpParams not related to Message-waiting can be used in an idle status or in the status of hearing a dial tone. This function with lpParams of MSGWAIT\_PLAY can be used in an idle status or the status of hearing a dial tone. If the application uses this when hearing a DVU message, the message will be replayed. If a wrong lpParams is transferred, or the line device does not have a DVU access right, or DVU board is not installed, or there is not available channel, or memory is insufficient, the IResult actual parameter of the corresponding ASYNC\_COMPLETION is LINEERR\_OPERATIONFAILED.

- **DVU (Digitized Voice Unit) (iPECS-LIK, MG)**

“ DVU/xx···x” in the lpParams field where xx···x is:

1. DATE; voice announcement of the date and the time.
2. STANO; voice announcement of the number of the station
3. STA\_STATUS; voice announcement of the following information of the station
  - Station Number
  - ICM Signaling Mode
  - Number of Message Waiting
  - Wake-up Time
  - DND state
  - Forwarded to other station
  - Forwarded to Speed Bin
  - Station COS X
4. ENTER; a user listens to “ Enter Password” message.
5. ENTER/xxx···xx; “ xxx···xx” is password. “ A user listens to “ You have one new message.” message.

To use dial pad, lineDevSpecific(“ PUSH\_BTN/x” ) function is used.

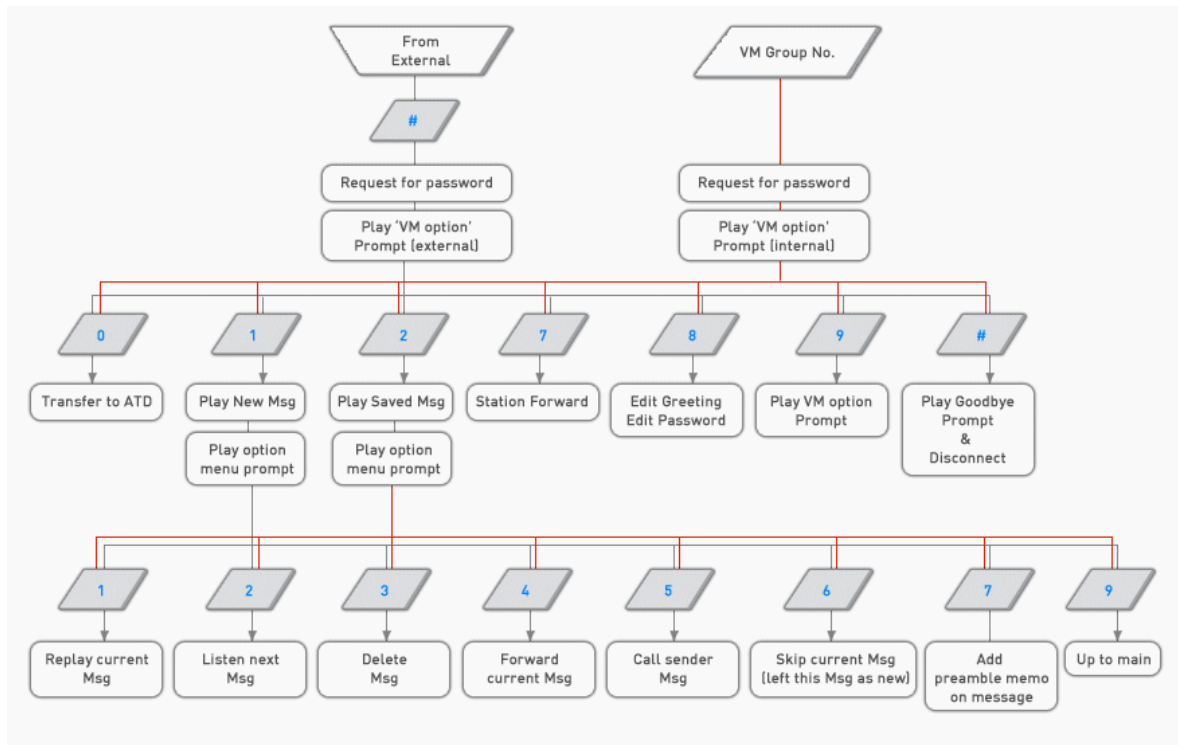

- **Get SMDR (Station Message Detail Recording) Data**

“ SMDR/x” in the lpParams field where x is:

1. B (Begin)
2. E (End)

This function enables or disables the application to receive the SMDR data. If the application uses this function with lpParams of “ SMDR/B” , the Ericsson-LG Enterprise TSP will send the application the device-specific message of SMDR whenever the SMDR data occurs from ipLDK system, and then, you can get the SMDR data using **lineGetAddressStatus** function. If the application doesn’ t want to receive any SMDR data from LDK, use this function with lpParams of “ SMDR/E” .

**Note:** ipLDK 3<sup>rd</sup> party mode only

- **Get Changed Station Status**

“ STA\_STATUS/x” in the lpParams field where x is:

1. B (Begin)
2. E (End)

This function enables or disables the application to receive the changed station status data. If the application uses this function with lpParams of “ STA\_STATUS/B” , the Ericsson-LG Enterprise TSP will send the application the device-specific message whenever any stations’ status is changed. The message will have the physical number of the station and the changed status data in its parameters. Refer to LINE\_DEVSPECIFIC message of the status. If the application doesn’ t want to receive any station status data from Ericsson-LG Enterprise TSP, use this function with lpParams of “ STA\_STATUS/E” .

The application can monitor the status changing of any station connected to the ipLDK system, even if the line of a station doesn’ t be open by the application.

*Note: ipLDK-50/100/300/600 1<sup>st</sup> party does not support this feature.*

- **Get Changed CO Line Status**

“ COL\_STATUS/x” in the IpParams field where x is:

1. B (Begin)
2. E (End)

This function enables or disables the application to receive the CO line status data. If the application uses this function with IpParams of “ COL\_STATUS/B” , the Ericsson-LG Enterprise TSP will send the application the device-specific message whenever the CO line status is changed. The message will have the physical number of the CO line and the changed status data in its parameters. Refer to LINE\_DEVSPECIFIC message of the status. If the application doesn't want to receive any CO line status data from Ericsson-LG Enterprise TSP, use this function with IpParams of “ COL\_STATUS/E” . The application can monitor the status changing of any CO line connected to the system.

*Note: ipLDK-50/100/300/600 1<sup>st</sup> party does not support this feature.*

*Note: iPECS-CM does not support*

- **Get All Station Status**

“ ALL\_STA\_STATUS” in the IpParams field

This function can tell the application the status of all stations. The status is described in 0 Device Specific Data Format. After the function is completed asynchronously, the LINE\_DEVSPECIFIC message is sent to the application. Then, the application can get the status data using **lineGetAddressStatus** function. Refer to LINE\_DEVSPECIFIC message and **lineGetAddressStatus** function.

The application can get the status of any station connected to the system, even if the line of a station doesn't be open by the application.

*Note: ipLDK-50/100/300/600 1<sup>st</sup> party does not support this feature.*

- **Get All CO Line Status**

“ ALL\_COL\_STATUS” in the IpParams field

This function can tell the application the status of all CO lines. The status is described in 0 Device Specific Data Format. After the function is completed asynchronously, the LINE\_DEVSPECIFIC message is sent to the application. Then, the application can get the status data using **lineGetAddressStatus** function. Refer to LINE\_DEVSPECIFIC message and **lineGetAddressStatus** function.

The application can get the status of any CO line connected to the system.

*Note: ipLDK-50/100/300/600 1<sup>st</sup> party does not support this feature.*

*Note: iPECS-CM does not support this feature.*

- **Get System Time**

“ GETTIME” in the IpParams field

This function can tell the application current Ericsson-LG Enterprise TSP server time. After the function is completed asynchronously, the LINE\_DEVSPECIFIC message is sent to the callback function. Refer to LINE\_DEVSPECIFIC.

*Note: 3<sup>rd</sup> party mode only*



- **Set CO Line Hold Type**

“ CO\_HOLD/xxx” in the IpParams field where xxx is:

1. EXC(Exclusive Hold)
2. SYS(System Hold)

This function sets the holding type of CO line. If an application holds a CO line using **lineHold**, the CO line will be held with the type that the application sets using this function. The default type of holding is Exclusive Hold.

**Note:** *iPECS-MG and iPECS-CM do not support this feature.*

- **Get Station' s Logical Number**

“ STA\_NUM/xxx” in the IpParams field where “ xxx” is the physical number of the station (eg. 001, 010, 100)

This function asks Ericsson-LG Enterprise TSP to return the logical number (station number) of the station. After asynchronous successful response of this function, the application will receive the LINE\_DEVSPECIFIC message, which contains the physical number and the logical number of the station in its parameters. Refer to LINE\_DEVSPECIFIC.

**Note:** *ipLDK-50/100/300/600 1<sup>st</sup> party does not support this feature.*

- **Get All Stations' Logical Numbers**

“ ALL\_STA\_NUM” in the IpParams field

This function asks Ericsson-LG Enterprise TSP to return the logical numbers (station number) of all stations. After asynchronous successful response of this function, the application will receive the LINE\_DEVSPECIFIC message. Then, the application can get the logical numbers of all stations by using **lineGetAddressStatus** function. Refer to LINE\_DEVSPECIFIC message and **lineGetAddressStatus** function.

**Note:** *ipLDK-50/100/300/600 1<sup>st</sup> party does not support this feature.*

- **Get Station Information**

“ STA\_INFO/xxx” in the IpParams field where “ xxx” is the physical number of the station (eg. 001, 010, 100)

This function asks Ericsson-LG Enterprise TSP to prepare to provide the information of the station, which has the physical number of “ xxx.” After asynchronous successful response of this function, the application will receive the LINE\_DEVSPECIFIC message. Then, the application can get the information of the station by using **lineGetAddressStatus** function. Refer to LINE\_DEVSPECIFIC message and **lineGetAddressStatus** function.

**Note:** *ipLDK-50/100/300/600 1<sup>st</sup> party does not support this feature.*

- **Get CO Line Information**

“ COL\_INFO/xxx” in the IpParams field where “ xxx” is the physical number of the CO line (eg. 001, 010, 100)

This function asks Ericsson-LG Enterprise TSP to prepare to provide the information of the CO line, which has the physical number of “ xxx.” After asynchronous successful response of this function, the application will receive the LINE\_DEVSPECIFIC message.

Then, the application can get the information of the station by using **lineGetAddressStatus** function. Refer to LINE\_DEVSPECIFIC message and **lineGetAddressStatus** function.

*Note: ipLDK-50/100/300/600 1<sup>st</sup> party does not support this feature.*

*Note: iPECS-CM does not support*

- **Get All Park Number**

“ ALL\_PARK\_NUM” in the IpParams field.

This function asks Ericsson-LG Enterprise TSP to prepare to provide the information of all park number. After asynchronous successful response of this function, the application will receive the LINE\_DEVSPECIFIC message. Then, the application can get the information of the station by using **lineGetAddressStatus** function. Refer to LINE\_DEVSPECIFIC message and **lineGetAddressStatus** function.

*Note: 3<sup>rd</sup> party mode only*

*Note: iPECS-CM supports this feature from TSP version D.2Af.*

- **Dummy Station Log on (ipLDK)**

“ LOGON/xxxx/yyyy” in the IpParams field where xxxx, yyyy are:.

xxxx: Station Number (3 or 4 digits)

yyyy: Password (Admin dependant).

- **Dummy Station Log on (iPECS-LIK, iPECS-CM)**

“ LOGON/xxxxyyyy” in the IpParams field where xxxx, yyyy are:.

xxxx: Station Number

yyyy: Password (Admin dependent).

- **Dummy Station Log off (ipLDK, iPECS-LIK)**

“ LOGOFF/xx...xx” in the IpParams field where xx...xx is:.

- NOCHANGE
- VMIB
- VMGROUP/yyyy, yyyy is a VM group number
- VMIB
- MOBILE
- STATION/xxxx, xxxx is a station number. Forward to Station.

- **Dummy Station Log off (iPECS-CM)**

“ LOGOFF/xx...xx” in the IpParams field where xx...xx is:.

- NOCHANGE
- STATION/xxxx, xxxx is an internal or external number.

- **UCD DND Log on/off in UCD group ( ipLDK)**

“ UCD\_DND\_ON/xxxx” in the IpParams: Activate UCD DND.

“ UCD\_DND\_OFF/xxxx” in the IpParams: Deactivate UCD DND.

- xxxx is a UCD group number.

“ S\_UCD\_DND\_ON/xxxx/yyyy” in the IpParams: Activate UCD DND by Supervisor.

- “ S\_UCD\_DND\_OFF/xxxx/yyyy” in the IpParams: Activate UCD DND by Supervisor.
  - xxxx is a UCD group number.
  - yyyy is a station number (3 or 4 digits)
  
- **UCD DND Log on/off in UCD group ( iPECS-LIK)**
  - “ UCD\_DND\_ON/xxxx/y” in the IpParams: Activate UCD DND.
  - “ UCD\_DND\_OFF/xxxx/y” in the IpParams: Deactivate UCD DND.
    - xxxx is a UCD group number.
    - y is one of the ‘ 0~9’ , ‘ #’ , ‘ \*’ .
  
  - “ S\_UCD\_DND\_ON/xxxx/yyyy/z” in the IpParams: Activate UCD DND by Supervisor.
  - “ S\_UCD\_DND\_OFF/xxxx/yyyy/z” in the IpParams: Deactivate UCD DND by Supervisor.
    - xxxx is a UCD group number.
    - yyyy is a station number (3 or 4 digits)
    - z is one of the ‘ 0~9’ , ‘ #’ , ‘ \*’ .
  
- **Make/delete Conference Room**
  - “ CONF\_ROOM/E/xxx/yyyyy” in the IpParams: Activate Conference Room.
  - “ CONF\_ROOM/D/xxx/yyyyy” in the IpParams: Deactivate Conference Room.
    - xxxx is a Conference Room number.
    - yyyyy is a password.
  
- **Get Call ID in a ACD group (iPECS-LIK)**
  - “ CO\_CALLID /xxx” in the IpParams.
    - xxxx is a ACD Group number.
  
- **Call Answer by Call ID (iPECS-LIK)**
  - “ CO\_CALLID\_ANS /xxx” in the IpParams.
    - xxxx is a Call ID number.
  
- **Off net Call Forward (ipLDK)**
  - “ OFFNET\_FORWARD/UNCOND/Cxxxxyy” in the IpParams.
  - “ OFFNET\_FORWARD/NOANSW/Cxxxxyy” in the IpParams.
  - “ OFFNET\_FORWARD/BUSYFW/Cxxxxyy” in the IpParams.
  - “ OFFNET\_FORWARD/BUSYNA/Cxxxxyy” in the IpParams.
  - “ OFFNET\_FORWARD/UNCOND/LOOPyyy” in the IpParams.
  - “ OFFNET\_FORWARD/NOANSW/LOOPyyy” in the IpParams.
  - “ OFFNET\_FORWARD/BUSYFW/LOOPyyy” in the IpParams.
  - “ OFFNET\_FORWARD/BUSYNA/LOOPyyy” in the IpParams.
    - OFFNET\_FORWARD is functional string of Off net Call Forward.
    - UNCOND means Unconditional Off net Call Forward.
    - NOANSW means No Answer Off net Call Forward.
    - BUSYFW means Busy Off net Call Forward.
    - BUSYNA means Busy No Answer Off net Call Forward.
    - C means Individual CO Line.
    - xxx is a CO number.

- yyy is a Speed Bin number.
- **Off net Call Forward (iPECS-LIK)**
  - “ OFFNET\_FORWARD/UNCOND/yyy” in the lpParams.
  - “ OFFNET\_FORWARD/NOANSW/yyy” in the lpParams.
  - “ OFFNET\_FORWARD/BUSYFW/yyy” in the lpParams.
  - “ OFFNET\_FORWARD/BUSYNA/yyy” in the lpParams.
  - yyy is a Speed Bin number.
  - The number of digits depends on system. (From 2 to 5 digits)
- **Push Button (Dial Pad)**
  - “ push\_btn/x” in the lpParams.
  - x is a dial digit (0 ~ 9, \*, #)
- **Send SMS Message**
  - “ SMS/W/xx...x /yy...y” in the lpParams.
  - xx...x : Destination Station Number
  - yy...y : SMS message

**Note:** Maximum length of SMS depends on System type.  
(cf. ipLDK : 48 chars; iPECS-MG : 100 chars; iPECS-LIK/UCP/eMG80/eMG800 : 80 chars; Others don't support this message.)

### lineDial

The **lineDial** function dials the specified dialable number on the specified call. The function is completed asynchronously.

```
LONG lineDial(  
    HCALL hCall,  
    LPCSTR lpszDestAddress,  
    DWORD dwCountryCode  
);
```

- **Account Code**
  - “ AC/xx...x” in the lpszDestAddress field where xx...x are account code digits which are within 12 digits.
  - These digits will be included in the SMDR data record. These can be used to allocate cost or time for the call.
  - This function can be used when the call (hCall) is in the connected status.
  - Note:** ipLDK 3<sup>rd</sup> party only
- **CO Call (ipLDK, iPECS-LIK)**
  - “ Cxx...x” or “ @xx...x” in the lpszDestAddress field where xs are 0 through 9,\*, and #. The front three xs represent CO line number and the following digits are real dialing numbers.
- **CO Call (iPECS-MG, CM )**
  - “ xx...x” in the lpszDestAddress field where xs are 0 through 9,\*, and #. (CO Access

Code + CO Number + real dialing numbers)

- **CO Group Call**  
“ Gxx…x” or “ \$xx…x” in the lpszDestAddress field where xs are 0 through 9, \*, and #. The front three xs represent CO line group number and the following digits are real dialing numbers.
- **CO Group Call (iPECS-MG, CM)**  
“ xx…x” in the lpszDestAddress field where xs are 0 through 9, \*, and #. (CO Group Access Code + dialing numbers)
- **Networking Call**  
“ xxx” in the lpszDestAddress field where xxx is extension number or station group number.
- **Outside/Long distance Call**  
“ ss…sxx…x” in the lpszDestAddress field where ss…s is the Outside Access or Long distance Access string you have described at Telephony of Control Panel in your computer, and the following digits are real dialing number. The same response, that comes out when you Dial 9(0 in some countries) and the following digits in your keyset, will come out.
- **Outside/Long distance Call (iPECS-MG, CM)**  
“ ss…sxx…x” in the lpszDestAddress field where ss…s is the Outside Access and the following digits are real dialing number.

Ericsson-LG Enterprise TSP ignores the value in the dwCountryCode field. Also, the following four special functions are supported:

- **Station Speed Dial (ipLDK, iPECS-LIK)**  
“ SPD/xx…x” in the lpszDestAddress field where xx…x is:
  1. “ Cyyyzzz” or “ @yyyzzz” where yyy is CO number and zzz is speed dial number.
  2. “ Gyyyzzz” or “ \$yyyzzz” where yyy is CO group number and zzz is speed dial number.
  3. “ zzz” where zzz is speed dial number.(000 ~ 099)
- **Station Speed Dial (iPECS-MG, CM)**  
“ SPD/xx…x” in the lpszDestAddress field where xx…x is:
  1. “ xxx” where xxx is speed dial number.(000 ~ 099)
- **System Speed Dial (ipLDK, iPECS-LIK)**  
“ SPD/xx” in the lpszDestAddress field where x is:
  1. “ Cyyyzzzz” or “ @yyyzzzz” where yyy is CO line number and zzzz is system speed dial number.

2. “ Gyyzzzz” or “ \$yyzzzz” where yyy is CO group number and zzzz is system speed dial number.
  3. “ zzzz” where zzzz is system speed dial number.(2000 ~ 4999)
- **System Speed Dial (iPECS-MG, CM)**  
“ SPD/xxxx” in the lpszDestAddress field where x is:
    1. “ xxxx” where xxxx is system speed dial number.(2000 ~ 4999)
  
  - **Last Number Redial(LNR) (ipLDK, iPECS-LIK)**  
“ LNR/xx··x” in the lpszDestAddress field where x is:
    1. “ Cyyy” or “ @yyy” where yyy is CO line number.
    2. “ Gyyy” or “ \$yyy” where yyy is CO group number.
    3. (None)
  
  - **Last Number Redial(LNR) (iPECS-MG, CM)**  
“ LNR” in the lpszDestAddress field
  
  - **Save Number Redial(SNR) (ipLDK, iPECS-LIK)**  
“ SNR/xx··x” in the lpszDestAddress field where x is:
    1. “ Cyyy” or “ @yyy” where yyy is CO line number.
    2. “ Gyyy” or “ \$yyy” where yyy is CO group number.
    3. (None)
  
  - **Save Number Redial(SNR) (iPECS-MG, CM)**  
“ SNR” in the lpszDestAddress field
  
  - **Make a call to a Conference Room (ipLDK, iPECS-LIK)**  
“ xxx/yyyyy” in the lpszDestAddress field where x is:
    1. “ xxx” is a Conference Room number.
    2. “ yyyy” is a password.
  
  - **Make a call to a Conference Room (iPECS-MG, CM)**  
“ xxxyyyyy\*” in the lpszDestAddress field where x is:
    1. “ xxx” is a Conference Room number.
    2. “ yyyy” is a password.
    3. ‘ \*’

### lineForward

The **lineForward** function forwards calls destined for the specified address on the specified line, according to the specified forwarding instructions. When an originating address

(dwAddressID) is forwarded, the specified incoming calls for that address are deflected to the other number by the switch. This function provides a combination of forward and do-not-disturb features. This function can also cancel forwarding currently in effect. The function is completed asynchronously.

```
LONG lineForward(  
    HLINE hLine,  
    DWORD bAllAddresses,  
    DWORD dwAddressID,  
    LPLINEFORWARDLIST const lpForwardList,  
    DWORD dwNumRingsNoAnswer,  
    LPHCALL lphConsultCall,  
    LPLINECALLPARAMS const lpCallParams  
);
```

- dwAddressID must be zero.
- Ericsson-LG Enterprise TSP supports the following functions:

- **DND (Do Not Disturb)**  
lpForwardList→ForwardList[0].dwDestAddressSize to NULL.
- **Forward all calls unconditionally.**  
lpForwardList→ForwardList[0].dwForwardMode to LINEFORWARDMODE\_UNCOND.
- **Forward any calls on busy.**  
lpForwardList→ForwardList[0].dwForwardMode to LINEFORWARDMODE\_BUSY.
- **Forward any calls on no answer.**  
lpForwardList→ForwardList[0].dwForwardMode to LINEFORWARDMODE\_NOANSW.
- **Forward any calls on busy/no answer.**  
lpForwardList→ForwardList[0].dwForwardMode to LINEFORWARDMODE\_BUSYNA.

### lineGetAddressStatus

The **lineGetAddressStatus** function allows an application to query the specified address for its current status.

```
LONG lineGetAddressStatus(  
    HLINE hLine,  
    DWORD dwAddressID,  
    LPLINEADDRESSSTATUS lpAddressStatus  
);
```

In the structure of lpAddressStatus, Ericsson-LG Enterprise TSP fills dwDevSpecificSize, dwDevSpecificOffset and the corresponding data field. Especially, Ericsson-LG Enterprise TSP can return SMDR, All Station Status, All CO Line Status, Station Information, CO Line Information, and All Station's Numbers. If a TAPI application want to get those data, those data receiving process must be started with **lineDevSpecific** function related to those data. Whenever those data occurs, the LINE\_DEVSPECIFIC message is sent to the callback function. Then, the application can get those data using this function. Refer to **lineDevSpecific** function (SMDR, All Station Status, All CO Line Status, Station Information, CO Line Information, and All Station's Number),

### lineGetCallInfo

The **lineGetCallInfo** function enables an application to obtain fixed information about the specified call.

```
LONG lineGetCallInfo(  
    HCALL hCall,  
    LPLINECALLINFO lpCallInfo  
);
```

Ericsson-LG Enterprise TSP fills dwCallerID, dwCallerIDName, dwCalledID, dwCalledIDName, dwConnectedID, dwConnectedIDName when proper ID and Name is received. The dwRedirectingID and dwRedirectingIDName are provided to the ringing station when the DID incoming call is forwarded from a station to another station. The dwRedirectionID and dwRedirectionIDName are unavailable.

### lineMakeCall

The **lineMakeCall** function places a call on the specified line to the specified destination address. Optionally, call parameters can be specified if anything but default call setup parameters are requested. The function is completed asynchronously.

```
LONG lineMakeCall(  
    HLINE hLine,  
    LPHCALL lphCall,  
    LPCSTR lpszDestAddress,  
    DWORD dwCountryCode,  
    LPLINECALLPARAMS const lpCallParams  
);
```

Ericsson-LG Enterprise TSP supports the following functions:

- **CO Call (ipLDK, iPECS-LIK)**  
“ Cxx…x” or “ @xx…x” in the lpszDestAddress field where xs are 0 through 9,\*, and #. The front three xs represent CO line number and the following digits are real dialing numbers.
- **CO Call (iPECS-MG, CM)**  
“ xx…x” in the lpszDestAddress field where xs are 0 through 9,\*, and #. (CO Access Code + CO Number + real dialing numbers)
- **CO Group Call (ipLDK, iPECS-LIK)**  
“ Gxx…x” or “ \$xx…x” in the lpszDestAddress field where xs are 0 through 9, \*, and #. The front three xs represent CO line group number and the following digits are real dialing numbers.
- **CO Group Call (iPECS-MG, CM)**  
“ xx…x” in the lpszDestAddress field where xs are 0 through 9, \*, and #. (CO Group Access Code + dialing numbers)



- **Networking Call**  
“ xxx” in the IpszDestAddress field where xxx is extension number or station group number.
- **Outside/Long distance Call (ipLDK, iPECS-LIK)**  
“ ss···sxx···x” in the IpszDestAddress field where ss···s is the Outside Access or Long distance Access string you have described at Telephony of Control Panel in your computer, and the following digits are real dialing number. The same response, that comes out when you Dial 9(0 in some countries) and the following digits in your keyset, will come out.
- **Outside/Long distance Call (iPECS-MG, CM)**  
“ ss···sxx···x” in the IpszDestAddress field where ss···s is the Outside Access and the following digits are real dialing number.

Ericsson-LG Enterprise TSP ignores the value in the dwCountryCode field. Also, the following four special functions are supported:

- **Station Speed Dial (ipLDK, iPECS-LIK)**  
“ SPD/xx···x” in the IpszDestAddress field where xx···x is:
  1. “ Cyyzzz” or “ @yyzzz” where yyy is CO number and zzz is speed dial number.
  2. “ Gyyzzz” or “ \$yyzzz” where yyy is CO group number and zzz is speed dial number.
  3. “ zzz” where zzz is speed dial number.(000 ~ 099)
- **Station Speed Dial (iPECS-MG, CM)**  
“ SPD/xxx” in the IpszDestAddress field where xxx is:
  1. “ xxx” where xxx is speed dial number.(000 ~ 099)
- **System Speed Dial (ipLDK, iPECS-LIK)**  
“ SPD/xx” in the IpszDestAddress field where x is:
  - 1 “ Cyyzzzz” or “ @yyzzzz” where yyy is CO line number and zzzz is system speed dial number.
  2. yyzzzz” or “ \$yyzzzz” where yyy is CO group number and zzzz is system speed dial number.
  3. “ zzzz” where zzzz is system speed dial number.
- **System Speed Dial (iPECS-MG, CM)**  
“ SPD/xxxx” in the IpszDestAddress field where x is:
  1. “ xxxx” where xxxx is system speed dial number.
- **Last Number Redial(LNR) (ipLDK, iPECS-LIK)**  
“ LNR/xx···x” in the IpszDestAddress field where x is:
  1. “ Cyyy” or “ @yyy” where yyy is CO line number.
  2. “ Gyyy” or “ \$yyy” where yyy is CO group number.
  3. (None)

- **Last Number Redial(LNR) (iPECS–MG, CM)**  
“ LNR” in the lpszDestAddress field
- **Save Number Redial(SNR) (ipLDK, iPECS–LIK)**  
“ SNR/xx···x” in the lpszDestAddress field where x is:
  1. “ Cyyy” or “ @yyy” where yyy is CO line number.
  2. “ Gyyy” or “ \$yyy” where yyy is CO group number.
  3. (None)
- **Save Number Redial(SNR) (iPECS–MG, CM)**  
“ SNR” in the lpszDestAddress field
- **Make a call to a Conference Room (ipLDK, iPECS–LIK)**  
“ xxx/yyyy” in the lpszDestAddress field where x is:
  1. “ xxx” is a Conference Room number.
  2. “ yyyy” is a password.
- **Make a call to a Conference Room (iPECS–MG, CM)**  
“ xxxyyyyy\*” in the lpszDestAddress field where x is:
  1. “ xxx” is a Conference Room number.
  2. “ yyyy” is a password.
  3. “ \*”

### lineNegotiateAPIVersion

The `lineNegotiateAPIVersion` function allows an application to negotiate an API version to use.

```
LONG lineNegotiateAPIVersion(  
    HLINEAPP hLineApp,  
    DWORD dwDeviceID,  
    DWORD dwAPILowVersion,  
    DWORD dwAPIHighVersion,  
    LPDWORD lpdwAPIVersion,  
    LPLINEEXTENSIONID lpExtensionID  
);
```

The negotiated API version number of Ericsson–LG Enterprise TSP with the pointer `lpdwAPIVersion` is

Low Version: 0x00010004  
High Version: 0x00020001

The extension identifiers of Ericsson–LG Enterprise TSP in the structure pointed by `lpExtensionID` are

`lpExtensionID->dwExtensionID0`: 0x0ccb18c0  
`lpExtensionID->dwExtensionID1`: 0x10202109  
`lpExtensionID->dwExtensionID2`: 0x80002f8d  
`lpExtensionID->dwExtensionID3`: 0xf354241e

### lineNegotiateExtVersion

The **lineNegotiateExtVersion** function allows an application to negotiate an extension version to use with the specified line device. This operation need not be called if the application does not support extensions.

```
LONG lineNegotiateExtVersion(  
    HLINEAPP hLineApp,  
    DWORD dwDeviceID,  
    DWORD dwAPIVersion,  
    DWORD dwExtLowVersion,  
    DWORD dwExtHighVersion,  
    LPDWORD lpdwExtVersion  
);
```

The negotiated extension version of Ericsson-LG Enterprise TSP with the pointer `lpdwExtVersion` is

Low Version: 0x00020001  
High Version: 0x00020001

### linePark

The **linePark** function parks the specified call according to the specified park mode. The function is completed asynchronously.

```
LONG linePark(  
    HCALL hCall,  
    DWORD dwParkMode,  
    LPCSTR lpszDirAddress,  
    LPVARSTRING lpNonDirAddress  
);
```

LINEPARKMODE\_NONDIRECTED in the field `dwParkMode` is applied only in 3<sup>rd</sup> party mode.

- Parking Area
  - ipLDK, iPECS-LIK: Admin dependent
  - iPECS-MG: 00 ~ 49
  - iPECS-CM: 000 ~ 999

### lineRedirect

The **lineRedirect** function redirects the specified offering call to the specified destination address.

```
LONG lineRedirect(  
    HCALL hCall,  
    LPCSTR lpszDestAddress  
    DWORD dwCountryCode  
);
```

If the offering call is external call, Ericsson-LG Enterprise TSP can support only the redirection of DID call.

### lineSetStatusMessages

The **lineSetStatusMessages** function enables an application to specify which notification messages to receive for events related to status changes for the specified line or any of its addresses.

```
LONG lineSetStatusMessages(  
    HLINE hLine,  
    DWORD dwLineStates,  
    DWORD dwAddressStates  
);
```

If this function is executed, you will receive the following messages:

- The number of Message Wait.
- The number of voice message
- Forward information
- The range of conference room (IP LDK or later version)

### 8.2 Phone Device Functions

The TAPI phone-device class functions supported by Ericsson-LG Enterprise TSP are described in the following table:

Function	Ericsson-LG Enterprise TSP Support
phoneClose	Supported.
phoneDevSpecific	Supported.
phoneGetData	Supported.
phoneGetDevCaps	Supported.
phoneGetID	Supported.
phoneInitializeEx	Supported.
phoneNegotiateAPIVersion	Supported.
phoneNegotiateExtVersion	Supported.
phoneOpen	Supported.
phoneShutdown	Supported.

#### phoneDevSpecific

The **phoneDevSpecific** function is used as a general extension mechanism to enable a Telephony API implementation to provide features not described in the other TAPI functions. The meanings of these extensions are device specific.

```
LONG phoneDevSpecific(  
    HPHONE hPhone,  
    LPVOID lpParams,  
    DWORD dwSize  
);
```

Ericsson-LG Enterprise TSP supports the following device-specific functions:

- **Wake-Up**

“ WU/xx···x” in the lpParams field where xx···x is:

1. HHMM (HH:hour, MM:minute)
2. HHMM/S (S:once)
3. HHMM/C (C:continuous)
4. HHMM/T (T: Tomorrow, iPECS-MG Only)
5. CURR (current): to get current wake up time. You will get the “ none” string if current wake up time does not be set.
6. DELE (delete): to delete current wake up time.

- **Authorization Code/Password**

“ ACP/xx···x” in the lpParams field where xx···x is:

1. yyyyy/zzzzz (yyyyy : old password, zzzzz : new password) where each y and z is 0 through 9,\*, and #. (ipLDK, iPECS-LIK)
2. NEWPW/yyyyy (yyyyy : new password) where y is 0 through 9,\*, and #.
3. CURPW: to get current password. If there is no current password, system returns

“ NOPAS.”

4. DELPW: to delete current password. (IPECS–MG, CM)

- **Temporal Station COS Change**

“ TSCC/xx···x” in the IpParams field where xx···x is:

1. C (current)
2. D (down, ipLDK, iPECS–LIK)
3. D/yyyy, (down, iPECS–MG, iPECS–CM, yyyy is a password)
4. R/yyyy (restore, yyyy is a password)

- **Preselected Message Program**

“ PMP/xx···x” in the IpParams field where xx···x is:

1. A message string that can contain alphabet, :, (, ), 0 through 9, or space character within 24 letters.
2. /CUR (current message), PMP//CUR
3. /DEL (delete message), PMP//DEL

- **ICM Answer Mode**

“ IAM/x” in the IpParams field where x is:

1. H (hands free mode)
2. T (tone ring mode)
3. P (privacy mode)
4. C (current)

- **BGM Assignment (ipLDK, iPECS–LIK, MG)**

“ BGM/xx” in the IpParams field where x is:

1. 00 (No use)
2. 01 (BGM Channel 1)
3. 02 (BGM Channel 2)
4. 03 (BGM Channel 3)
5. 04 (BGM Channel 4)
6. 05 (BGM Channel 5)
7. 06 (BGM Channel 6)
8. 07 (BGM Channel 7)
9. 08 (BGM Channel 8)
10. 09 (BGM Channel 9)
11. 10 (BGM Channel 10)
12. 11 (BGM Channel 11)
13. 12 (BGM Channel 12)
14. Cu(Current BGM Channel)

- **Preselected Message Selection**

“ PMS/mm/xx···x” in the IpParams field where mm is:

1. 00: Display preselected message programmed in each station. “ /xx···x” must not be set.
2. 01: Display “ LUNCH / RETURN AT hh:mm” where xx···x is hhmm.

3. 02: Display “ ON VACATION / RETURN AT dd mon” where xx···x is ddmm.
  4. 03: Display “ OUT OF OFFICE / RETURN AT hh:mm” where xx···x is hhmm.
  5. 04: Display “ OUT OF OFFICE / RETURN AT dd mon” where xx···x is mmdd.
  6. 05: Display “ OUT OF OFFICE / RETURN UNKNOWN” where /xx···x must not be set.
  7. 06: Display “ CALL : telephone number” where xx···x is telephone number (Max: 18 digits).
  8. 07: Display “ IN OFFICE : STA ssss” where xx···x is ssss.
  9. 08: Display “ IN A MEETING / RETURN TIME hh:mm” where xx···x is hhmm.
  10. 09: Display “ AT HOME.” “ /xx···x” must not be set.
  11. 10: Display “ AT BRANCH OFFICE” where /xx···x must not be set.
  12. 11 – 20: Display preselected messages programmed in attendant. (ipLDK, iPECS-LIK Only)
  13. 21: Current preselected message where /xx···x must not be set.
  14. 99: Unset current preselected message.
- **Differential Ring** (Digital Keypad Only, ipLDK, iPECS-LIK)  
“ DR/x” in the IpParams field where x is:
    1. 1 ~ 4 (Ring Type)
    2. 0 (Current Ring Type)
  - **LCD Language Mode (ipLDK, iPECS-LIK)**  
“ LLM/x” in the IpParams field where x is:
    1. 0 (English)
    2. 1 (Corresponding Country)
    3. 2 (Current)
  - **LCD Language Mode (iPECS-MG, CM)**  
“ LLM/xx” in the IpParams field where x is:
    1. 00 (English)
    2. 01 (Italian)
    3. 02 (Finnish)
    4. 03 (Dutch)
    5. 04 (Swedish)
    6. 05 (Danish)
    7. 06 (Norwegian)
    8. 07 (Hebrew)
    9. 08 (German)
    10. 09 (French)
    11. 10 (Portuguese)
    12. 11 (Spanish)
    13. 12 (Korean)
    14. 13 (Estonian)

15. 14 (Russian)
  16. 15 (Turkish) (iPECS-CM only)
  17. 16 (Polish) (iPECS-CM only)
  18. 17 (Greek) (iPECS-CM only)
  19. 99 (Current)
- **Headset Mode Program (ipLDK, iPECS-LIK)**  
“ HMP/x” in the lpParams field where x is:
    1. 0 (Headset mode off)
    2. 1 (Headset mode on)
    3. 2 (Current)
  - **Headset Mode Program (iPECS-MG, CM)**  
“ HMP/x” in the lpParams field where x is:
    1. 0 (Speaker)
    2. 1 (Headset)
    3. 2 (Ear Mic)
    4. 3 (Bluetooth)
    5. 4 (Current)

### phoneGetData

The **phoneGetData** function uploads the information from the specified location in the open phone device to the specified buffer.

```
LONG phoneGetData(  
    HPHONE hPhone,  
    DWORD dwDataID,  
    LPVOID lpData,  
    DWORD dwSize  
);
```

Ericsson-LG Enterprise TSP supports the following functions:

- **Wake-Up**  
“ 0x01” in the dwDataID field  
The lpData field and its meaning are:
  1. DELET: No setting
  2. HHMMF where HH:hour, MM:minute, F: C(continuous)/S(single)
- **Authorization Code/Password**  
“ 0x02” in the dwDataID field  
The lpData field and its meaning are:
  1. NOPAS: No password
  2. xxxxx: Current password
- **Temporal Station COS Change**  
“ 0x03” in the dwDataID field  
The lpData field and its meaning are:
  1. D: COS Down
  2. R: COS Restored



- **Preselected Message Program**  
“ 0x04” in the dwDataID field  
The IpData field and its meaning are:
  1. xx…x: null terminated string
- **ICM Answer Mode**  
“ 0x05” in the dwDataID field  
The IpData field and its meaning are:
  1. H: hands free
  2. T: Tone ring
  3. P: Privacy
- **BGM Assignment**  
“ 0x06” in the dwDataID field  
The IpData field and its meaning are:
  1. 0: not in use
  2. x: channel no(1 or 2)
- **Preselected Message Selection**  
“ 0x07” in the dwDataID field  
The IpData field and its meaning are:
  1. /mm/xx…x where mm is message number and xx…x is the related string. Refer to **phoneDevSpecific** function
- **Differential Ring (Digital Keyphone Only, ipLDK, iPECS-LIK Only)**  
“ 0x08” in the dwDataID field  
The IpData field and its meaning are:
  1. x: ring type(1-4)
- **LCD Language Mode (ipLDK, iPECS-LIK)**  
“ 0x09” in the dwDataID field  
The IpData field and its meaning are:
  1. 0: English
  2. 1: Domestic
- **LCD Language Mode (iPECS-MG, CM)**  
“ 0x09” in the dwDataID field  
The IpData field and its meaning are:
  1. 00: English
  2. 01: Italian
  3. 02: Finnish
  4. 03: Dutch
  5. 04: Swedish
  6. 05: Danish
  7. 06: Norwegian
  8. 07: Hebrew
  9. 08: German
  10. 09: French
  11. 10: Portuguese
  12. 11: Spanish
  13. 12: Korean
  14. 13: Estonian

15. 14: Russian
  16. 15: Turkish (iPECS-CM only)
  17. 16: Polish (iPECS-CM only)
  18. 17: Greek (iPECS-CM only)
- **Headset/Speakerphone Mode Program (ipLDK, iPECS-LIK)**  
“ 0x0B” in the dwDataID field  
The IpData field and its meaning are:
    1. 0: Speaker
    2. 1: Headset
  - **Headset/Speakerphone Mode Program (iPECS-MG, CM)**  
“ 0x0B” in the dwDataID field  
The IpData field and its meaning are:
    1. 0: Speaker
    2. 1: Headset
    3. 2: Ear Mic
    4. 3: Bluetooth

### phoneNegotiateAPIVersion

The **phoneNegotiateAPIVersion** allows an application to negotiate an API version to use for the specified phone device.

```
LONG phoneNegotiateAPIVersion(  
    HPHONEAPP hPhoneApp,  
    DWORD dwDeviceID,  
    DWORD dwAPILowVersion,  
    DWORD dwAPIHighVersion,  
    LPDWORD lpdwAPIVersion,  
    LPPHONEEXTENSIONID lpExtensionID  
);
```

The negotiated API version number of Ericsson-LG Enterprise TSP with the pointer lpdwAPIVersion is

Low Version: 0x00010004  
High Version: 0x00020001

The extension identifiers of Ericsson-LG Enterprise TSP in the structure pointed by lpExtensionID are

lpExtensionID->dwExtensionID0: 0x7bdc3120  
lpExtensionID->dwExtensionID1: 0x10204a78  
lpExtensionID->dwExtensionID2: 0x8000318d  
lpExtensionID->dwExtensionID3: 0xf354241e

### phoneNegotiateExtVersion

The **phoneNegotiateExtVersion** function allows an application to negotiate an extension version to use with the specified phone device. This operation need not be called if the application does not support extensions.

```
LONG phoneNegotiateExtVersion(  
    HPHONEAPP hPhoneApp,  
    DWORD dwDeviceID,  
    DWORD dwAPIVersion,  
    DWORD dwExtLowVersion,  
    DWORD dwExtHighVersion,  
    LPDWORD lpdwExtVersion  
);
```

The negotiated extension version of Ericsson-LG Enterprise TSP with the pointer `lpdwExtVersion` is

Low Version: 0x00020001

High Version: 0x00020001

### 8.3 Device Specific Messages

#### LINE\_DEVSPECIFIC

The LINE\_DEVSPECIFIC message is sent to notify the application about device-specific events occurring on a line, address, or call. The meaning of the message and the interpretation of the parameters are described below.

<pre>LINE_DEVSPECIFIC dwDevice = (DWORD) hLineOrCall; dwCallbackInstance = (DWORD) hCallback; dwParam1 = (DWORD) DeviceSpecific1; dwParam2 = (DWORD) DeviceSpecific2; dwParam3 = (DWORD) DeviceSpecific3;</pre>
---

Ericsson-LG Enterprise TSP sends this message to application to notify the following events:

- **SMDR, All Station Status, All CO Line Status have received.** (Refer to `lineDevSpecific` function)  
hLine in the dwDevice field,  
“ 0x01” in the dwParam1 field.
  1. SMDR data is received.  
“ 0x01” in the dwParam2 field.
  2. All Station Status data is received.  
“ 0x04” in the dwParam2 field.
  3. All CO Line Status data is received.  
“ 0x05” in the dwParam2 field.
  4. All Station Numbers are received..  
“ 0x08” in the dwParam2 field.
  5. Station Information is received.  
“ 0x09” in the dwParam2 field.
  6. CO line Information is received.  
“ 0x0A” in the dwParam2 field.
  7. All Park Numbers are received.  
“ 0x0B” in the dwParam2 field.
  8. CO Call IDs are received.  
“ 0x10” in the dwParam2 field.

After receiving this message, the application can get the data using `lineGetAddressStatus` function.

**Note:** 3<sup>rd</sup> party mode only

- **The UserUserInfo data have been accumulated over 2.**  
hCall in the dwDevice field,  
“ 0x02” in the dwParam1 field,  
“ xx” in the dwParam2 field where xx is the number of accumulated `UserUserInfo` data.

- **The response of “ Get System Time” in lineDevSpecific function has received.**  
hLine in the dwDevice field,  
“ 0x03” in the dwParam1 field,  
“ yyyy mmmm” in the dwParam2 field where yyyy is year, mmmm is month,  
“ ddhhmmss” in the dwParam2 field where dd is date, hh is hour, mm is minute, ss is second.
  - **The MSGWait (ICM number) has received.**  
hLine in the dwDevice field,  
“ 0x04” in the dwParam1 field,  
“ x” in the dwParam2 field where x is 0x01(ON) or 0x00(OFF),  
“ y” in the dwParam3 field where y is the station number which leave the waiting message (DWORD).
  - **DVU MSG has received.**  
hLine in the dwDevice field,  
“ 0x05” in the dwParam1 field,  
“ 0x01” in the dwParam2 field,  
“ x” in the dwParam3 field where x is received DVU message number.
  - **DND state has changed.**  
hLine in the dwDevice field,  
“ 0x06” in the dwParam1 field,  
“ 0x01” in the dwParam2 field,  
“ x” in the dwParam3 field where x is 0x01(ON) or 0x00(OFF).
  - **The station’ s state has changed to DVU Forwarded.**  
hLine in the dwDevice field,  
“ 0x06” in the dwParam1 field,  
“ 0x02” in the dwParam2 field.
  - **Preselected Message Selection has changed.**  
hLine in the dwDevice field,  
“ 0x06” in the dwParam1 field,  
“ 0x03” in the dwParam2 field,  
“ x” in the dwParam3 field where x is 0x01(ON) or 0x00(OFF).  
*Note: It just shows whether preselected message selection is programmed to stations or not. If ‘ x’ is equal to ON, one of several pre-defined preselected message is set to the station. If ‘ x’ is equal to OFF, preselected message is deactivated. To get detailed information about preselected message selection status, **phoneGetData (Preselected Message Selection : dwDataID == 0x07)** function can be used.*
  - **Station number related to physical number is sent.**
-

hLine in the dwDevice field,  
“ 0x07” in the dwParam1 field,  
“ x” in the dwParam2 field where x is the physical number of the station in DWORD,  
which has described in **lineDevSpecific** function,  
“ y” in the dwParam3 field where y is the station number of the station, x, in 4-byte characters.

**Note:** 3<sup>rd</sup> party mode only

- **Station Status has changed.**

hLine in the dwDevice field,  
“ 0x08” in the dwParam1 field,  
“ x” in the dwParam2 field where x is the physical number of the station in DWORD,  
“ y” in the dwParam3 field where y is the changed status of the station. (Status is described in 0 Device Specific Data Format)

**Note:** 3<sup>rd</sup> party mode only

- **CO Line Status has changed.**

hLine in the dwDevice field,  
“ 0x09” in the dwParam1 field,  
“ x” in the dwParam2 field where x is the physical number of the CO line in DWORD,  
“ y” in the dwParam3 field where y is the changed status of the CO line. (Status is described in 0 Device Specific Data Format)

**Note:** 3<sup>rd</sup> party mode only

- **My Station Status has changed.**(Opened line’ s status has changed)

hLine in the dwDevice field,  
“ 0x0B” in the dwParam1 field,  
“ x” in the dwParam2 field where x is the changed status of my station in DWORD,  
(Status is described in 0 Device Specific Data Format)

**Note:** 3<sup>rd</sup> party mode only

- **Wake up ring**

hLine in the dwDevice field,  
“ 0x10” in the dwParam1 field,  
“ x” in the dwParam2 field where x is 0x01(Ring) or 0x00(Stop),

- **Linked Pair**

hLine in the dwDevice field,  
“ 0x11” in the dwParam1 field,  
“ x” in the dwParam2 field where x is 0x01(Slave is in use) or 0x00(Stop),

**Note:** 1. The master receives CTI Message, but the slave doesn’ t.  
2. When the slave is in use, the master can’ t use CTI Functions

- **Park Number (ip-LDK, iPECS-LIK)**

hLine in the dwDevice field,  
“ 0x12” in the dwParam1 field,

“ x” in the dwParam2 field where x is the Park number.

“ y” in the dwParam3 field where y is the CO line.

- **Park Number : when a parked device is station or invalid (iPECS-MG, iPECS-CM)**

hLine in the dwDevice field,

“ 0x13” in the dwParam1 field,

“ x” in the dwParam2 field where x is the Park number.

“ y” in the dwParam3 field where y is the Station Number.

*Note1: x, y are interger value not ascii value. If Park number is 1 then x is not ‘ 0x20 20 20 31’ but ‘ 0x00000001’ . If Station Number is 100 then y is not ‘ 0x20 31 30 30’ but ‘ 0x00000064’ .*

*Note2: When a parked device is invalid, y is ‘ 0xFFFFFFFF’*

- **Park Number : when a parked device is CO line (iPECS-MG, iPECS-CM)**

hLine in the dwDevice field,

“ 0x14” in the dwParam1 field,

“ x” in the dwParam2 field where x is the Park number.

“ y” in the dwParam3 field where y is the CO line number.

*Note: x, y are interger value not ascii value. If Park number is 1 then x is not ‘ 0x20 20 20 31’ but ‘ 0x00000001’ . If CO line number is 5 then y is not ‘ 0x20 20 20 35’ but ‘ 0x00000005’ .*

- **The number of flexible buttons**

hLine in the dwDevice field,

“ 0x20” in the dwParam1 field,

“ x” in the dwParam2 field where x is the System type.

“ y” in the dwParam3 field where y is the number of flexible button of device.

*Note: This message will be generated when TSPL\_lineSetStatusMessages function is called..*

- **SMS Message has received**

hLine in the dwDevice field,

“ 0x22” in the dwParam1 field,

“ x” in the dwParam2 field where x is 0x00 (Internal SMS) or 0x01 (PSTN SMS)

- **MON button usage in case of DECT phone**

hLine in the dwDevice field,

“ 0x34” in the dwParam1 field,

“ 0” in the dwParam2 field.

“ 0” in the dwParam3 field.

*Note: If the device type is DECT phone and MON button usage is enabled, this message will be generated when TSPL\_lineSetStatusMessages function is called.*

- **Station number has changed**

hLine in the dwDevice field,  
“ 0x36” in the dwParam1 field,  
“ x” in the dwParam2 field where x is the Port Number  
“ y” in the dwParam3 field where y is the Changed Station number  
Ex) If the changed station number is 100,  
    ipLDK and iPECS-LIK contain 0x20 0x31 0x30 0x30 in dwParam3.  
    iPECS-MG contains 0x00 0x00 0x00, 0x64 in dwParam3.

- **Range of Conference Room**

hLine in the dwDevice field,  
“ 0x37” in the dwParam1 field,  
“ x” in the dwParam2 field where x is the Start Number  
“ y” in the dwParam3 field where y is the Last number

- **Dummy Station**

hLine in the dwDevice field,  
“ 0x38” in the dwParam1 field,  
“ x” in the dwParam2 field where x is 0x00(Normal Keypad) or 0x01(Dummy Keypad).  
“ y” in the dwParam3 field where y is 0x00(Logon State) or 0x01(Dummy State).

- **UCD DND has changed**

hLine in the dwDevice field,  
“ 0x39” in the dwParam1 field,  
“ x” in the dwParam2 field where x is 0x00(OFF) or 0x01(ON).  
“ y” in the dwParam3 field where x is a UCD group number.

- **Get CO Call ID & DID Number (When you call lineDevSpecific(“ COL\_INFO/xxx” ))**

hLine in the dwDevice field,  
“ 0x40” in the dwParam1 field,  
“ x” in the dwParam2 field where x is a call ID.  
“ y” in the dwParam3 field where x is a DID number.

- **The Keypad has restarted**

hLine in the dwDevice field,  
“ 0xFE” in the dwParam1 field,  
“ 0x01” in the dwParam2 field.

- **The Keypad line has been disconnected**

hLine in the dwDevice field,  
“ 0xFE” in the dwParam1 field,  
“ 0x03” in the dwParam2 field.

- **System has restarted**

hLine in the dwDevice field,  
“ 0xFF” in the dwParam1 field,



“ 0x02” in the dwParam2 field.

***Note:** When system is restarted, every line will receive this message. According to line' s condition, the line should have a proper initialization process because system will not keep all previous call information like talking or ringing after restart. This initialization process may contain the process of keyset restart or keyset line disconnection.*

### Device Specific Data Format

If an application requests SMDR, All Station Status, All CO Line Status for the line device using **lineDevSpecific** function, Ericsson-LG Enterprise TSP gathers the data and sends the application message of each data. Then, the application can obtain the data using **lineGetAddressStatus**. In the LINEADDRESSSTATUS structure of the function, Ericsson-LG Enterprise TSP fills **dwDevSpecificSize**, **dwDevSpecificOffset**, and attaches the corresponding data, which is represented as following. (Refer to **lineGetAddressStatus** in this document and in *Microsoft Platform SDK*)

- **SMDR Data Format**

0	1	2	3	4	5	6	7	8	9	10	11	12	13	14	15	16	17
S	M	D	R	_	D	A	T	A	Nu	Nu	Nu	Nu	Nu	Total size			
FrameNum0				FrameSize0				FrameData0									
FrameData0(unfixed size)																	
FrameNum1				FrameSize1				FrameData1									
FrameData1(unfixed size)																	

- SMDR\_DATA : ascii string, “ SMDR\_DATA” (9 bytes)
- Nu : NULL character
- TotalSize : the total size of SMDR DATA format (4 bytes)
- FrameNum : the number of FrameData (4 bytes)
- FrameSize : the size of FrameData (4 bytes)
- FrameData : SMDR data (unfixed size). Refer to the following table

## TSP User Guide

Field Name	No. of bytes	Descriptions
Sequential number	4	Sequential number (range 0000 ~ 9999)
Space	1	
Station	5	Station number (2, 3, or 4 digits) CO number (CO xxx)
Space	1	
CO	3	CO Line number
Time	8	Call time serviced, 01:10:05(HH:MM:SS)
Space	1	
Start time	14	Start time, 25/11/01 14:20
Space	1	
Record type	1	t : Incoming CO transfer I : incoming CO (answered) O : outgoing CO T : outgoing CO transfer H : hold lost R : ring lost G : Group call lost
Dialed digits	18	Dialed digits (string)
Space	2	
Account group	2	Account Group Number field.
Space	1	
Metering count	5	Call metering count (record type : O, T)
Space	1	
Call cost	11	Call Cost (record type : O, T)
Space	1	
Account code	12	Account code field.

- **Station Status Data Format**

0	1	2	3	4	5	6	7	8	9	10	11	12	13	14	15
S	T	A	_	S	T	A	T	U	S	Nu	Nu	Total size			
Frame0			Frame1			Frame2			...						
...															

- STA\_STATUS : ascii string, " STA\_STATUS" (10 bytes)
- Nu : NULL character
- Total size : total size of Station Status Data Format in byte (4 bytes)
- Frame0, Frame1, ... Frame<sub>Max</sub> : All Station Status Data frame (3 bytes)

0 - 1	2
X	Y

X : physical number of station (physical number is order of connection of the station to the system)

Y : one of the following status values

	Status	Hexa value
Station Status	ST_INVALID	0x01
	ST_SLAVE	0x02
	ST_HOLD	0x11
	ST_RING	0x12
	STEXT_IDLE	0x40
	STEXT_IDLE_WITH_DND	0x41
	STEXT_ICM	0x43
	STEXT_COL	0x44
	STEXT_PGM	0x45
ST_BUSY	0x10	

- **CO Line Status Data Format**

0	1	2	3	4	5	6	7	8	9	10	11	12	13	14	15
C	O	L	_	S	T	A	T	U	S	Nu	Nu	Total size			
Frame0			Frame1			Frame2			...						
...															

- COL\_STATUS : ascii string, “ COL\_STATUS” (10 bytes)
- Nu : NULL character
- Total size : total size of CO Line Status Data Format in byte (4 bytes)
- Frame0, Frame1, ... Frame<sub>Max</sub> : All CO Line Status Data frame (3 bytes)

0 - 1	2
X	Y

X : physical number of CO line (physical number is order of connection of the CO line to system)

Y : one of the following status values

	Status	Hexa value
CO Line Status	ST_INVALID	0x01
	ST_HOLD	0x11
	ST_RING	0x12
	STTRK_IDLE	0x80
	STTRK_HOLD_RECALL	0x81
	STTRK_HOLD_ATDRECALL	0x82
	STTRK_IDLE_WITH_DISABLE	Not Support
ST_BUSY	0x10	

- **All Station' s Logical Number Data Format (ipLDK, iPECS-LIK 4digit)**

0	1	2	3	4	5	6	7	8	9	10	11	12	13	14	15
S	T	A	_	N	U	M	B	E	R	Nu	Nu	Total Size			
Nu <sub>0</sub>		Nu <sub>1</sub>		Nu <sub>2</sub>		...									
...											Nu <sub>n</sub>				

- STA\_NUMBER : ascii string, “ STA\_NUMBER” (10 bytes)
- Nu : NULL character

- Total size : total size of All Station' s Logical Number Data Format in bytes (4 bytes)
- Nu<sub>0</sub> : logical(assigned internal) number of the first station in integer(2 byte)
- Nu<sub>1</sub> : logical(assigned internal) number of the second station in integer(2 byte)
- Nu<sub>n</sub> : logical(assigned internal) number of the *n* th station in integer(2 byte)

- **All Station' s Logical Number Data Format (iPECS-MG, CM, iPECS-LIK 8 digit)**

0	1	2	3	4	5	6	7	8	9	10	11	12	13	14	15
S	T	A	_	N	U	M	B	E	R	Nu	Nu	Total Size			
Nu <sub>0</sub>				Nu <sub>1</sub>			Nu <sub>2</sub>			...					
...										Nu <sub>n</sub>					

- STA\_NUMBER : ascii string, “ STA\_NUMBER” (10 bytes)
- Nu : NULL character
- Total size : total size of All Station' s Logical Number Data Format in bytes (4 bytes)
- Nu<sub>0</sub> : logical(assigned internal) number of the first station in integer(4 byte)
- Nu<sub>1</sub> : logical(assigned internal) number of the second station in integer(4 byte)
- Nu<sub>n</sub> : logical(assigned internal) number of the *n* th station in integer(4 byte)

- **Station Information Data Format (ipLDK, iPECS-LIK)**

0	1	2	3	4	5	6	7	8	9	10	11	12	13	14	15
S	T	A	_	I	N	F	O	Nu	Nu	Nu	Nu	Total Size			
Pn	Sta Number			Sl	St	At	Ap		Ns	Sta Name ~					

- STA\_INFO : ascii string, “ STA\_INFO” (8 bytes)
- Nu : NULL character
- Total size : total size of Station Information Data Format in byte (4 bytes)
- Pn : physical number of the station (2 byte)
- Sta Number : the number of the station in DWORD (4-byte integer)  
(ex> 0x00000064 : station 100)
- Sl : slot number of the station in system (1 byte)
- St : status of the station. Refer to the Station Status value (1 byte)
- At : type of the associated device (1 byte)
  - 0x01 : the station is connected to a station
  - 0x02 : the station is connected to a CO line
  - 0x00/0xFF : the station is not connected
- Ap : physical number of the associated device (2 byte)  
(ex> At = 0x02, Ap = 0x0001 : the station is now using CO line 01)
- Ns : size of the station' s name (1 byte)
- Sta Name : name of the station (size of Ns)

- **CO Line Information Data Format**

0	1	2	3	4	5	6	7	8	9	10	11	12	13	14	15
C O L _ I N F O								Nu	Nu	Nu	Nu	Total Size			
Pn		St	At	Ap		Ns	Cs	CO Name							
CallerID															

- COL\_INFO : ascii string, “ COL\_INFO” (8 bytes)
- Nu : NULL character
- Total size : total size of CO Line Information Data Format in byte (4 bytes)
- Pn : physical number of the CO line (2 byte)
- St : status of the CO line. Refer to the CO Line Status value (1 byte)
- At : type of the associated device (1 byte)
  - 0x01 : the CO line is connected to a station
  - 0x02 : the CO line is connected to a CO line
  - 0x00/0xFF : the station is not connected
- Ap : physical number of the associated device (2 byte)  
(ex> At = 0x01, Ap = 0x0001 : the CO line is used by first station)
- Ns : size of the CO line name (1 byte)
- Cs : size of the CallerID of the CO line (1 byte)
- CO Name : name of the CO line (size of Ns)
- CallerID : CallerID of the CO line (size of Cs)

- **All Park Number Data Format (ipLDK, iPECS-LIK)**

0	1	2	3	4	5	6	7	8	9	10	11	12	13	14	15
A L L _ P A R K _ N U M												Total Size			
Nu <sub>0</sub>				Nu <sub>1</sub>				Nu <sub>2</sub>				...			
...								Nu <sub>n</sub>							

- ALL\_PARK\_NUM : ascii string, “ ALL\_PARK\_NUM” (12 bytes)
- Total size : total size of ALL Park Number Data Format in byte (4 bytes)
- Nu<sub>0</sub> : The first park number(4 byte)
- Nu<sub>1</sub> : The second park number(4 byte)
- Nu<sub>2</sub> : The third park number(4 byte)

- **All Park Number Data Format (iPECS-MG)**

0	1	2	3	4	5	6	7	8	9	10	11	12	13	14	15
A L L _ P A R K _ N U M												Total Size			
Nu <sub>0</sub>		Nu <sub>1</sub>		Nu <sub>2</sub>								...			
...								Nu <sub>n</sub>							

- ALL\_PARK\_NUM : ascii string, “ ALL\_PARK\_NUM” (12 bytes)
- Total size : total size of ALL Park Number Data Format in byte (4 bytes)
- Nu<sub>0</sub> : The first park number(2 byte)

- Nu<sub>1</sub> : The second park number(2 byte)
- Nu<sub>2</sub> : The third park number(2 byte)

- **All Park Number Data Format (iPECS-CM)**

0	1	2	3	4	5	6	7	8	9	10	11	12	13	14	15
A	L	L	_	P	A	R	K	_	N	U	M	Total Size			
Nu <sub>0</sub>			Nu <sub>1</sub>			Nu <sub>2</sub>						...			
...								Nu <sub>n</sub>							

- ALL\_PARK\_NUM : ascii string, “ ALL\_PARK\_NUM” (12 bytes)
- Total size : total size of ALL Park Number Data Format in byte (4 bytes)
- Nu<sub>0</sub> : The first park number(3 byte)
- Nu<sub>1</sub> : The second park number(3 byte)
- Nu<sub>2</sub> : The third park number(3 byte)

- **Station SMS Message Data Format (iPECS-MG)**

0	1	2	3	4	5	6	7	8	9	10	11	12	13	14	15
S	M	S	_	M	E	S	S	A	G	E	Nu	Total Size			
Nu <sub>0</sub>	SMS ( Nu <sub>0</sub> bytes)														
Nu <sub>1</sub>	CLI ( Nu <sub>1</sub> bytes)					Nu <sub>2</sub>	Date(Mon, Day, Hour, Min)								

- SMS\_MESSAGE : ascii string, “ SMS\_MESSAGE” (11 bytes)
- Nu : NULL character
- Total size : total size of Internal SMS Message Data Format in byte (4 bytes)
- Nu<sub>0</sub> : The length of SMS message in bytes (1 byte)
- SMS : SMS message string (Nu<sub>0</sub> bytes)
- Nu<sub>1</sub> : The length of the SMS sender’ s CLI. That is the length of station number (1 byte)
- CLI : Sender’ s CLI or Station Number (Nu<sub>1</sub> bytes)
- Nu<sub>2</sub> : The length of SMS date field, Usually 8 (1 byte)
- Date : SMS date. That is Mon(2bytes), Day(2bytes), Hour(2bytes) and Min(2bytes).

- **PSTN SMS Message Data Format (iPECS-MG)**

0	1	2	3	4	5	6	7	8	9	10	11	12	13	14	15
S	M	S	_	M	E	S	S	A	G	E	Nu	Total Size			
Nu <sub>0</sub>	SMS ( Nu <sub>0</sub> bytes)														
Nu <sub>1</sub>	CLI ( Nu <sub>1</sub> bytes)					Nu <sub>2</sub>	Date(Mon, Day, Hour, Min)								

- PSTN\_SMS\_MSG : ascii string, “ PSTN\_MSM\_MSG” (12 bytes)
- Nu : NULL character
- Total size : total size of PSTN SMS Message Data Format in byte (4 bytes)
- Nu<sub>0</sub> : The length of SMS message in bytes (1 byte)
- SMS : SMS message string (Nu<sub>0</sub> bytes)
- Nu<sub>1</sub> : The length of the SMS sender’ s CLI. That is the length of station number (1 byte)

## TSP User Guide

---

- CLI : Sender' s CLI or Station Number ( $Nu_1$  bytes)
- $Nu_2$  : The length of SMS date field, Usually 8 (1 byte)
- Date : SMS date. That is Mon(2bytes), Day(2bytes), Hour(2bytes) and Min(2bytes).

- **Co Call ID Data Format (ipLDK, iPECS-LIK)**

0	1	2	3	4	5	6	7	8	9	10	11	12	13	14	15
C	O	L	_	C	A	L	L	_	I	D	Nu	Total Size			
ACD				Nc	Cn1		Cn2		Cn3		Cn4		...		

- COL\_CALL\_ID : ascii string, “ COL\_CALL\_ID” (11 bytes)
- Nu : NULL character
- Total size : total size of Co Call ID Data Format in byte (4 bytes)
- ACD : ACD group number (4 byte)
- Nc: The number of Call IDs (1 byte)
- $Cn_1$  : The first Call ID (2 byte)
- $Cn_2$  : The second Call ID (2 byte)



### 9. Troubleshooting

- Lines and phones can not be seen on the server with the **tapimgmt.msc** command

**Cause:** The connection between Ericsson-LG Enterprise system and Ericsson-LG Enterprise TSP does not work correctly.

**Solution:** Ensure the following:

- 3<sup>rd</sup> party lock key is set up correctly.
- After installing Ericsson-LG Enterprise TSP, you should restart your computer.
- Ensure the Ericsson-LG Enterprise TSP configurations.

- One or more client computers cannot see the telephony server.

**Cause:** The server cannot be reached on the network because it is not set up correctly.

**Solution:** Ensure the following:

- The client computers can successfully log on to a domain.
- The client computers can successfully see the server with the **ping** command.
- That the telephony server has been configured correctly.

- Client computers cannot see lines on the telephony server.

**Cause:** The telephony server has not been set up correctly, or users have not been authorized to access lines on the server.

**Solution:** When a TAPI-based program accesses lines on the telephony server, the user who is running the program process is first authenticated. For the user to see the lines, they must have been assigned to the user. Ensure that the server has been set up correctly and that the user is assigned lines on the server.

- A client user cannot see lines or phones on the telephony server even though the server is set up correctly and the lines or phones have been assigned to the user.

**Cause:** The client computer has not been enabled to use the telephony server.

**Solution:** Use **tcmsetup** on the client computer to specify the telephony server.

- A client user cannot see a new line on the telephony server, even though the server administrator has assigned the user to the line.

**Cause:** When you assign a currently running client user to a line on the telephony server, the new settings will not be available until the user restarts the telephony service on the client computer.

**Solution:** Stop all client TAPI applications on the client so that the telephony service will shut down. When the client applications restart, they will be able to see the newly allocated lines. If you cannot get TAPI to shut down, restart the client computer.

- A client logon ID must be used in English and digits.
- Edit the lmhosts.sam – No response or Long delay time between the TAPI server and a client.

If a subnet of client computer IP address and a subnet of TAPI server IP address are different, it takes long time to get the TAPI information between the TAPI server and a client.

The lmhosts.sam file is a static file that assists with remote NetBIOS name resolution on computers that cannot respond to NetBIOS name-query broadcasts. It contains NetBIOS name-to-IP addresses mappings.

To edit the lmhosts.sam

1. Open lmhosts.sam

Typically, the lmhosts file is stored in the systemroot\System32\Drivers\Etc folder.

2. Add NetBIOS name-to-IP Address
3. Save the file.

To configure TCP/IP to use WINS

1. Open **Network and Dial-up Connections**

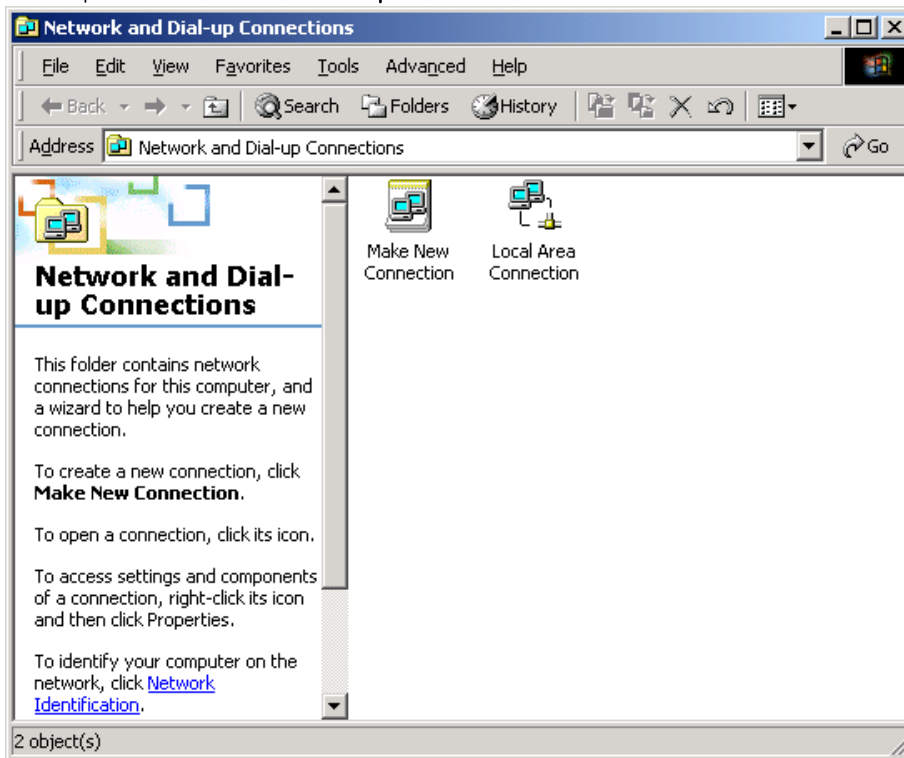

2. Right-click the network connection you want to configure, and then click **Properties**.

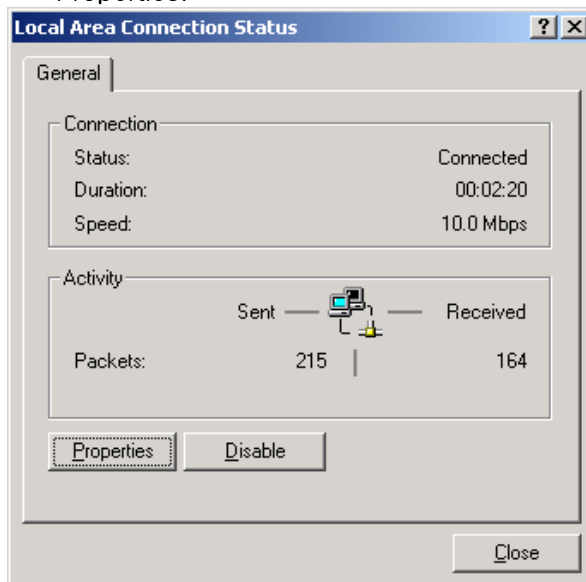

3. On the **General** tab (for a local area connection) or the **Networking** tab (all other connections), click **Internet Protocol (TCP/IP)**, and then click **Properties**.

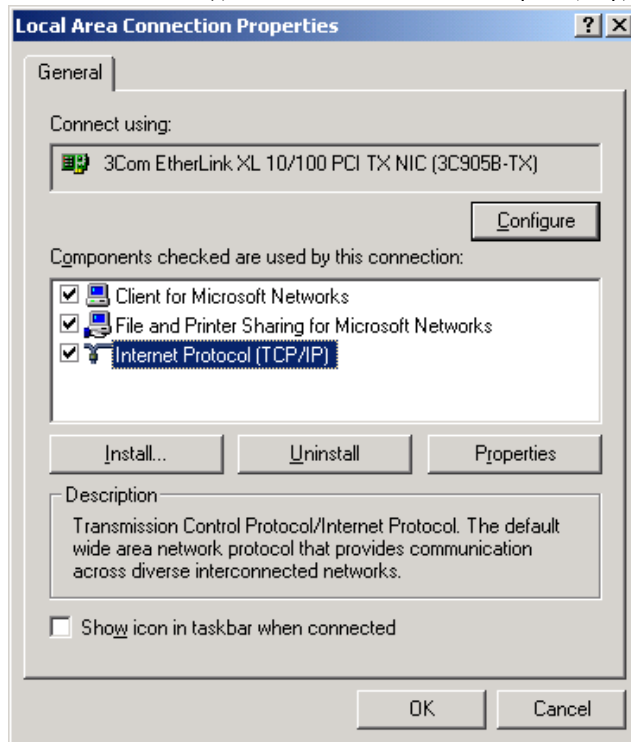

4. Click **Advanced**, click the **WINS** tab.

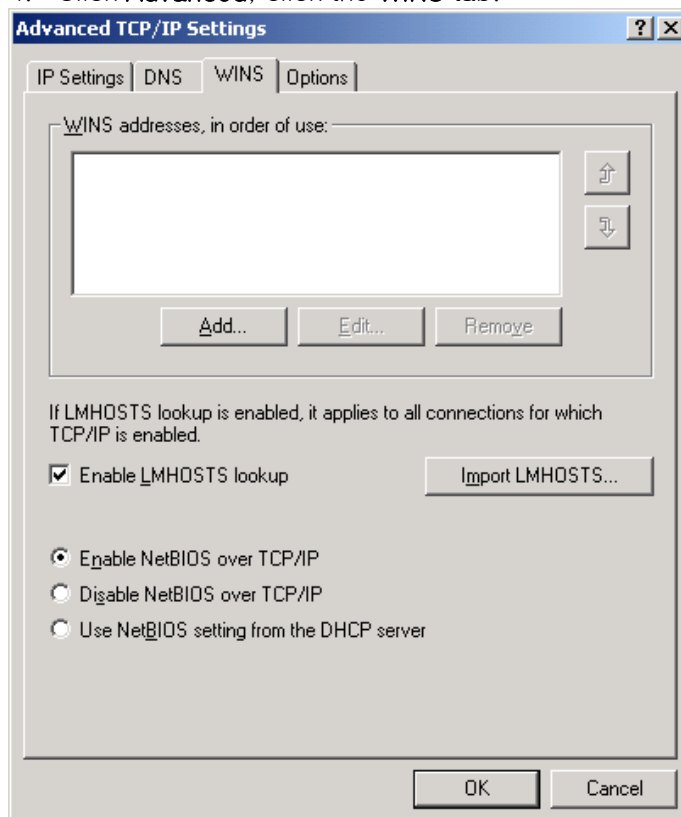

## TSP User Guide

---

To enable the use of the lmhosts file to resolve remote NetBIOS names, select the **Enable LMHOSTS lookup** check box. This option is enabled by default.

To specify the location of the file that you want to import into the lmhosts file, click **Import LMHOSTS**, and select the file in the **Open** dialog box.